

EST. 1994



Weaver Barns *ltd.*
"everyone needs a little structure in their life"

**BUILD
YOUR
DREAM SPACE**

www. **weaverbarns**.com

SHEDS & BARNNS



Gable page 20



Manchester page 22



Sugarcreek page 24



Craftsman page 26



Estate page 28



Woodshed page 30



Highland page 32



Grand Junction page 34



Studio page 36



Skür page 38



Easton page 40



Shed Addition page 42

BACKYARD BASICS



Jackson page 46



Addison page 47



New Haven page 48



Camden page 49

BACKYARD LIVING



Laredo page 51



Timber Ridge page 52



Bradford page 54



Lakewood page 56



Dublin page 58

GARAGES



Gable Garage page 64



Workshop page 66



Classic page 68



Heritage page 70



Rockport page 72



Willow Creek page 74



Cascade page 76



Dutch Garage page 78



Dutch Barn page 80

CABINS



Frontier page 82



Aspen page 84

HOMES



Rocky Ridge page 87



Cedar Brooke page 88



Cedar Brooke page 89



Timber Lodge page 90



Grand Lake page 91

Check out our home brochures for more information!

DESIGNING YOUR PERFECT SPACE

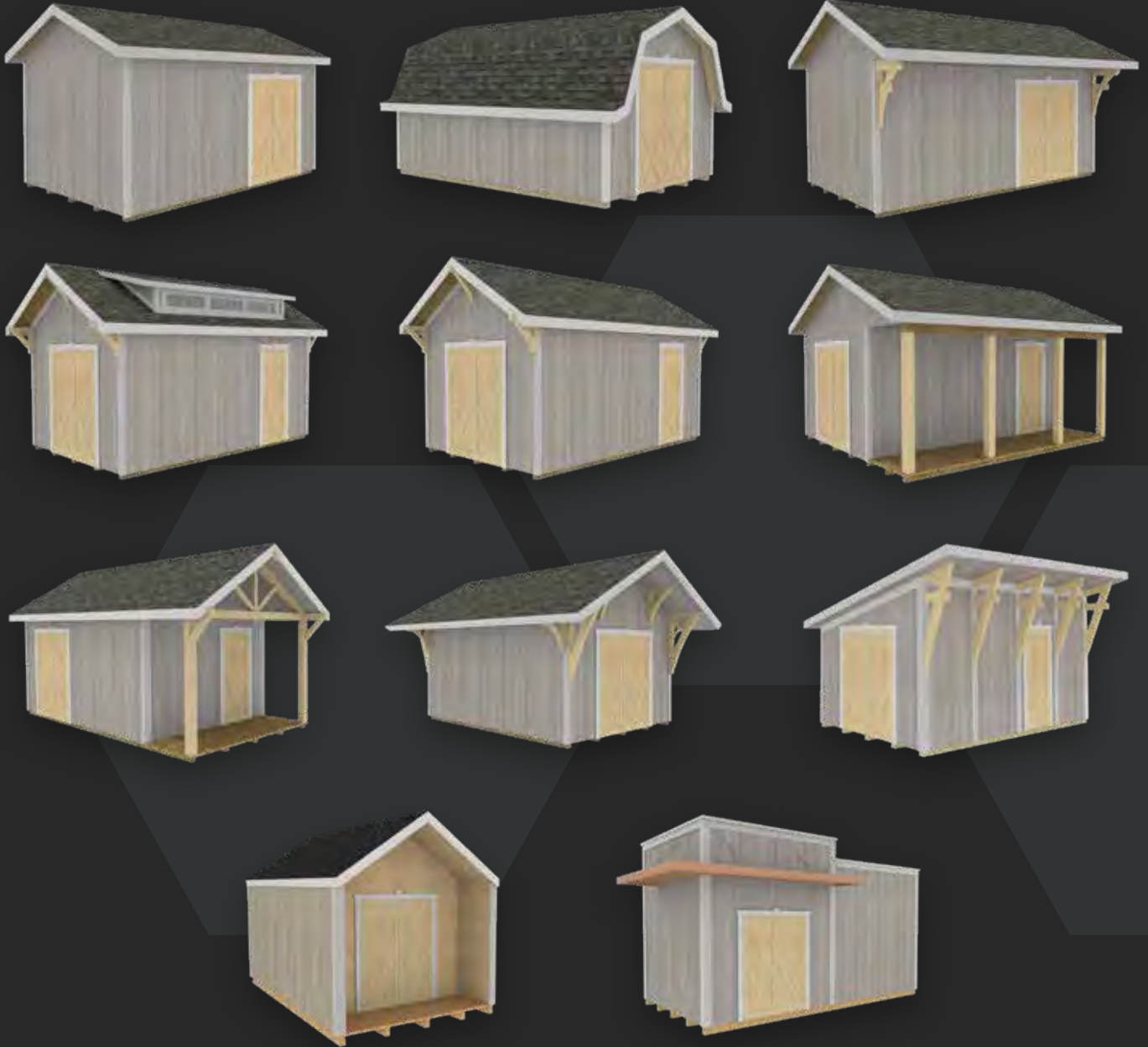

CHOOSE A BASE DESIGN

BASIC

All of our products can be configured the way you want it. We make this easy, with options and accessories to make it yours.



MAKE IT YOURS

PERSONALIZED



WELCOME

Since 1994 Weaver Barns has been building two things—structures and a reputation for unmatched quality. We strive to provide the best in everything we do, from customer service to manufacturing to installation. Quite simply, we provide you an excellent product that you and your family will enjoy for many years to come.



Weaver Barns *ltd.*
"everyone needs a little structure in their life"









DESIGN STYLES

To find a style that best fits your standards, we have a large variety of features for you to choose from. These styles are all unique and customizable, so you can find one that fits best into your space. Unlike other brands, our designs are not only based on appearance, but also on their functionality and durability. If you aren't sure what style will work best for your structure, our team is always eager to help guide you by giving recommendations specific to you and what you're looking for.





OLD WORLD GARDEN FARMS

Weaver Barns gives flexibility, the ability to customize, and most importantly, quality, to each customer we serve. Customers Jim and Mary from *Old World Garden Farms* fell in love with our designs and their ability to customize our structures to work specifically for their needs. Featured on this page are a few of the structures we have built with them. You can find more features on these building projects at their home and garden website. oldworldgardenfarms.com





STRENGTH

A No Compromise Approach to Quality

At Weaver Barns, our culture is quality. Every aspect of the projects we do is done right. We care about building something that will last. We understand that our customers need a space that will stand the test of time. From custom milling our floor boards to buying premium grade lumber, to using the finest materials we can source, we do not just build a shed, we build the Weaver way.



FOUNDATION TYPES

BLOCK SITE PREP

*Not Recommended For Grades Exceeding 8"

Place 8" x 16" x 4" cement blocks underneath the skids. Every skid needs a block at the front and back and then additional blocks need to be placed in the middle spaced not more than 6' apart.

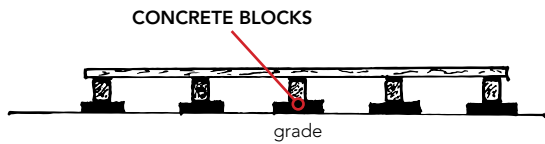

LIMESTONE PAD

*The Most Popular Choice For Sheds

Spread 4" of #57 limestone in a level pad 12" beyond the width and the length of the building on all sides. Also, you may want to use a 4 x 4 as an edge as shown in the example below.

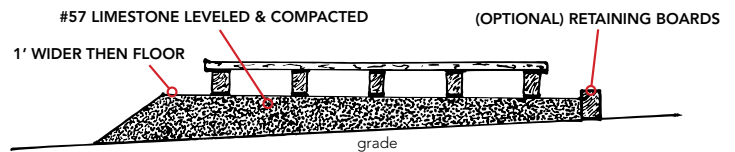

CONCRETE FOUNDATIONS

Pour the pad 1/2" less than the dimensions of the building. We attached treated plates to the bottom of the walls protecting the walls from moisture and rot. These bottom plates are fastened to the concrete pad with anchors or bolts.

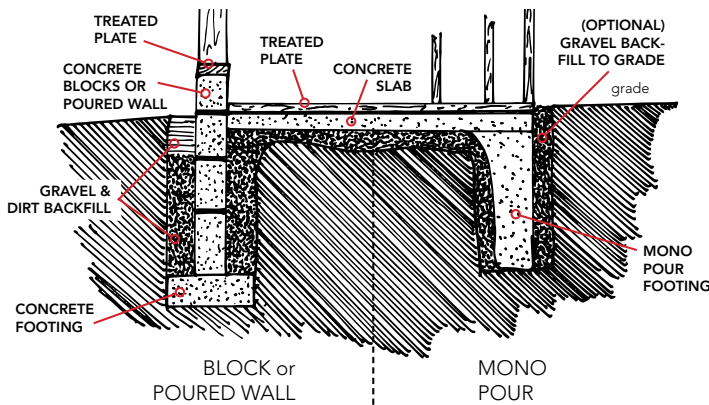

POST PLATFORM FOUNDATION

Use treated posts. Dig the post holes 32" - 42" deep. Place post pad or concrete in the bottom of the hole. Insert posts. Fasten cross beam joists with bolts to posts as shown making sure that the entire structure is square.

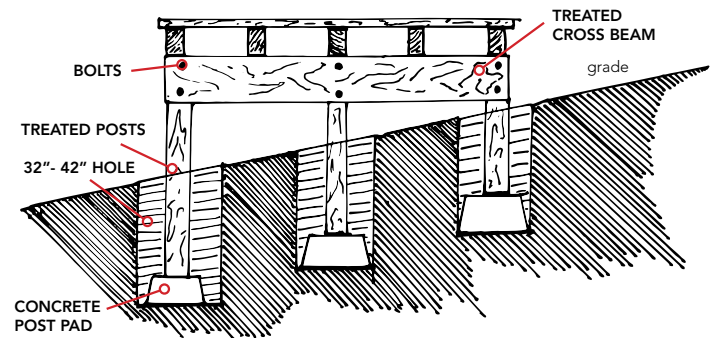

SHED ON SLAB

To attach a shed to a slab, have your concrete contractor add a 4" reinforced curb. This will keep water from entering the structure.

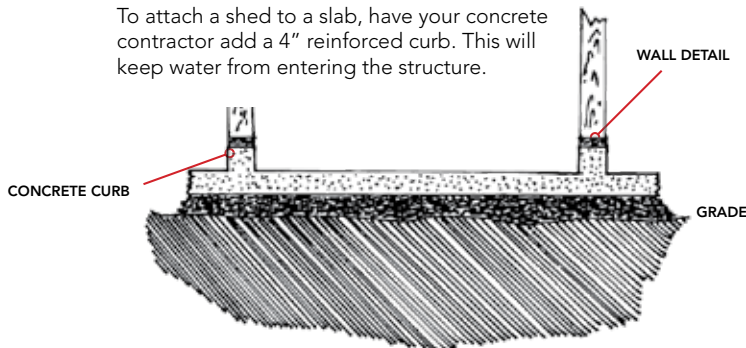

SKID PLACEMENT

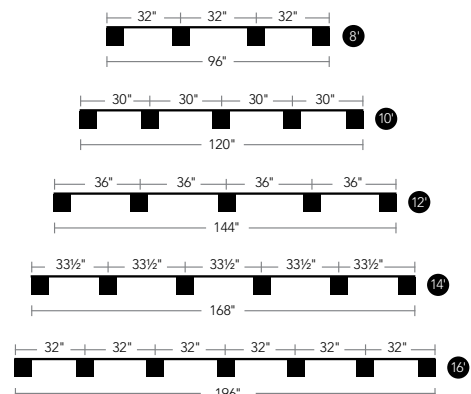

OUR PRICES INCLUDE DELIVERY

WE DELIVER TO YOUR SITE

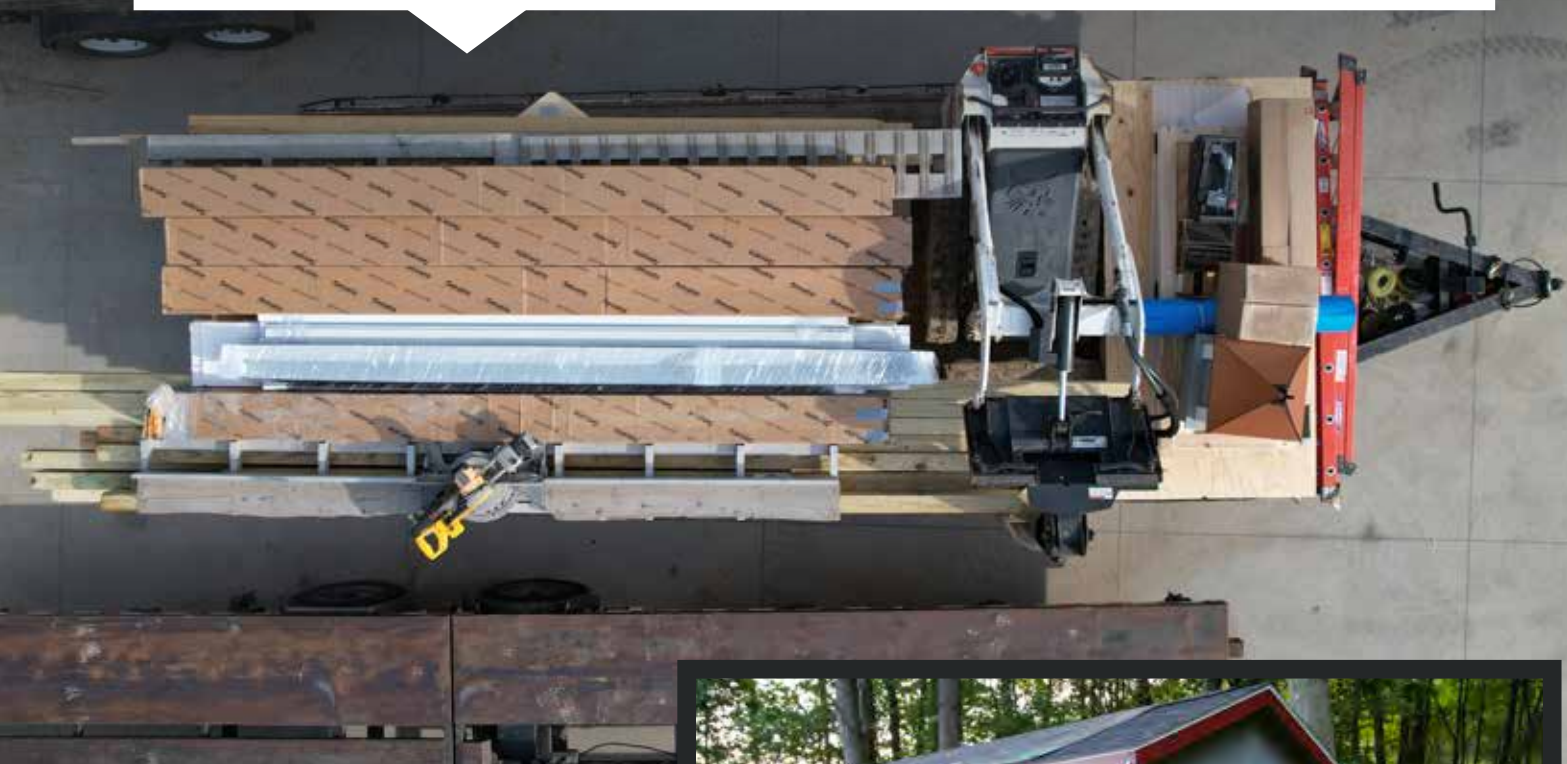

**PREBUILT &
DELIVERED**



— OR —

**DELIVERED &
BUILT ON SITE**



DAY OF DELIVERY

BEYOND FREE DISTANCE APPLIES
\$1.00 Per Foot Carry Charge

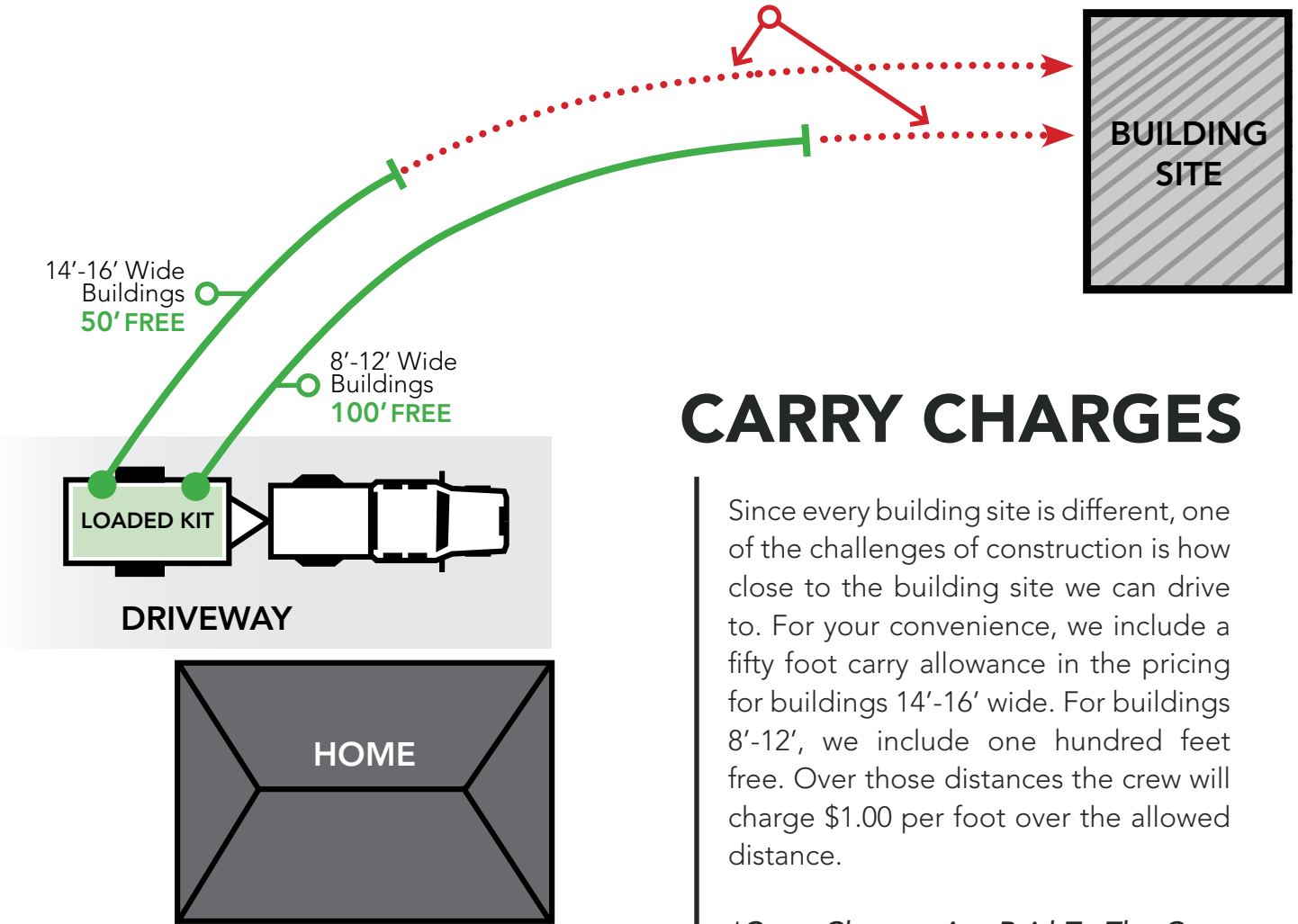

CARRY CHARGES

Since every building site is different, one of the challenges of construction is how close to the building site we can drive to. For your convenience, we include a fifty foot carry allowance in the pricing for buildings 14'-16' wide. For buildings 8'-12', we include one hundred feet free. Over those distances the crew will charge \$1.00 per foot over the allowed distance.

**Carry Charges Are Paid To The Crew Directly*



WHAT SIZE IS RIGHT?

When determining what size is right for your structure, we encourage you to talk to one of our qualified team members to figure out what works best for you. There are a lot of decisions that go into creating a structure, and we want to make that process as easy as possible for you, whether it's a custom garage or even a shed.

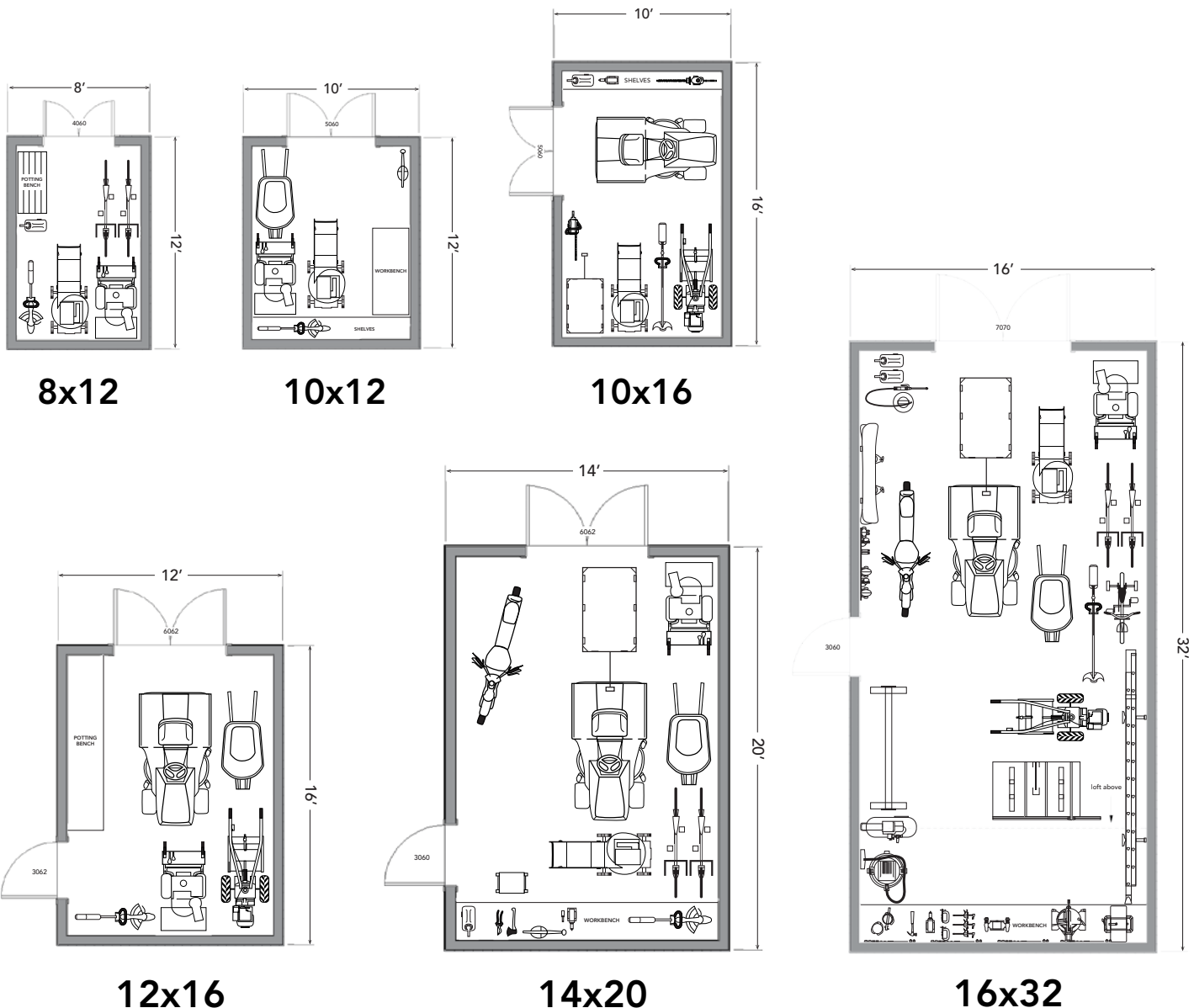

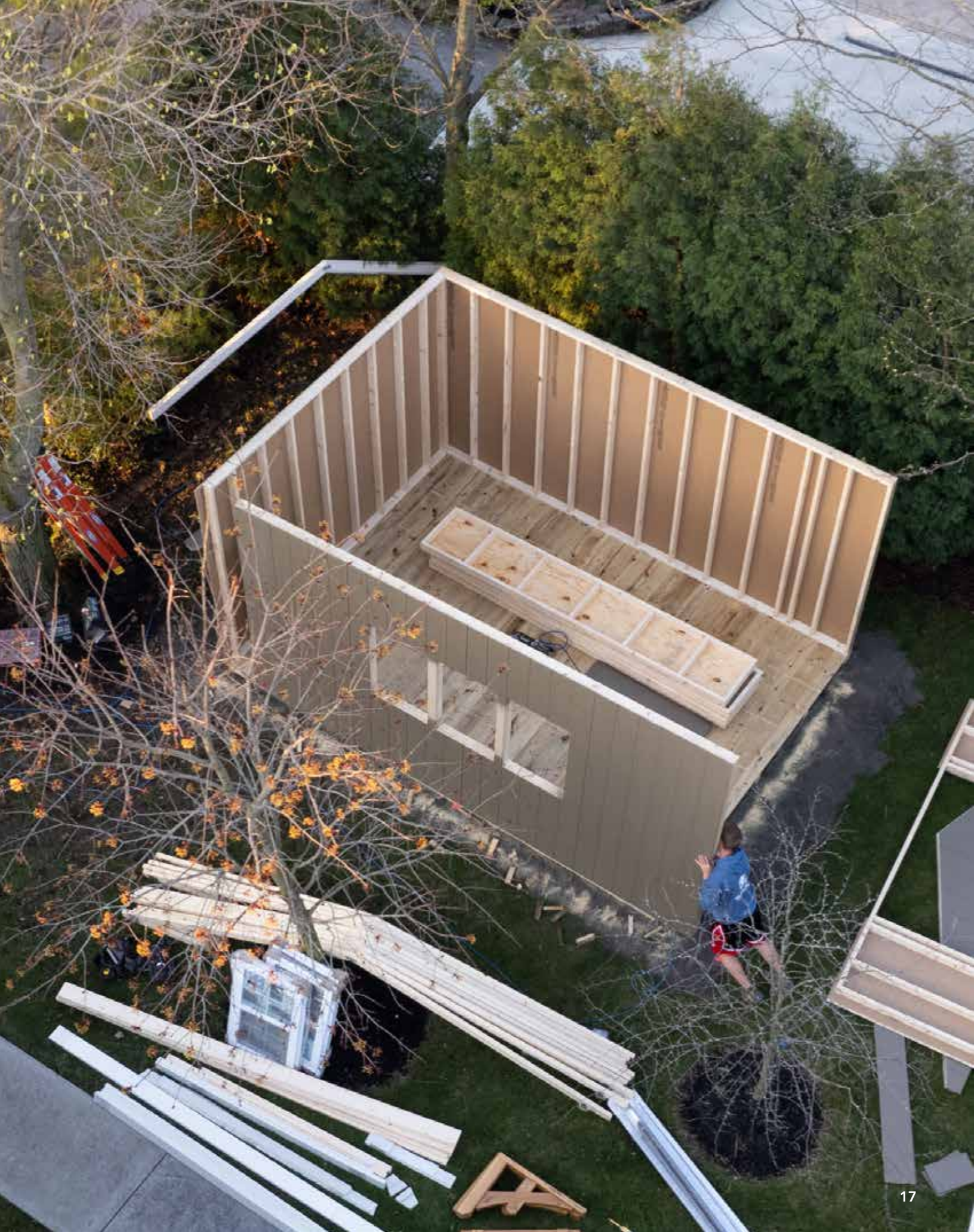



SUPERIOR FEATURES

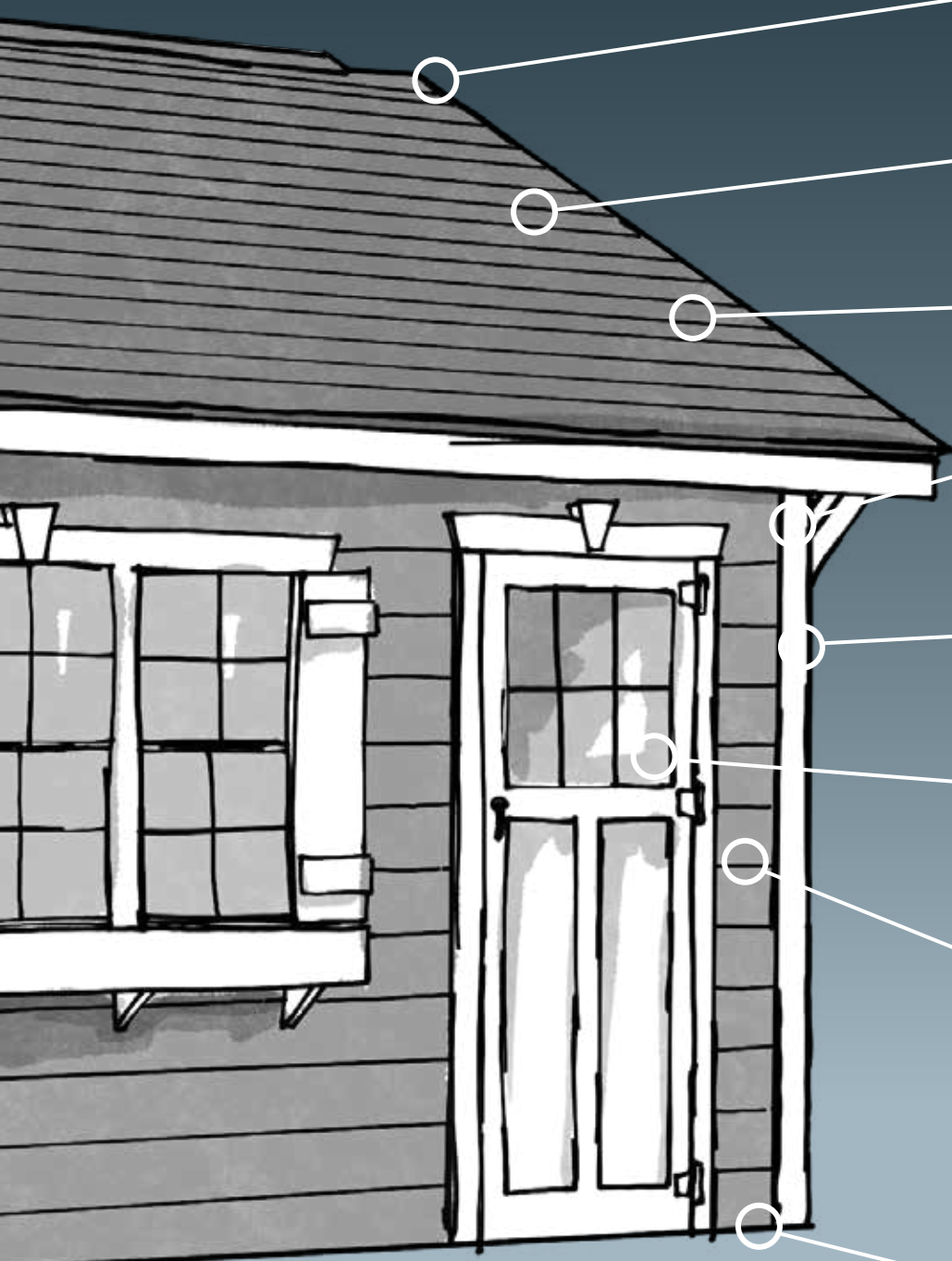

COOLER

Engineered Ventilation System
EXTENDS SHED LIFESPAN

ROOFING FELT

Extra Moisture Protection
EXTENDS SHED LIFESPAN

STRONGER ROOF

Superior Plywood Strength
ROOF SHEATHING

WEATHER PROTECTED

ROT RESISTANT TRIM PROTECTS
FROM MOISTURE DAMAGE

MORE STORAGE

7' 3 1/2" High
HIGHER WALLS

STURDY DOORS

Triple Layer Door (with drop rods)
SOLID CEDAR

SUPERIOR FRAMING

Premium Grade
BETTER LUMBER

2X6 Double Door Headers
2x4 Double Stud Door Frames
STRONGER DOOR FRAMES

16 Inches On Center
STRONGER STUDS & RAFTERS

TOUGHER FLOOR

Rated 1,000 lb. per sq. ft. (pressure treated)
HEAVIEST FLOOR in the Industry

STANDARD ON SIGNATURE SERIES

SIDING CHOICES

LP LAP SIDING

- 50 YEAR LIMITED WARRANTY
- Natural Wood Grain Texture
- 100% Clear
- Pre-Primed
- 50 Year Limited Warranty



VINYL SIDING

- Maintenance Free
- .044 Thickness
- Match Your Home
- CDX Plywood SubSiding



PINE SIDING

- 1 x 8 Premium Grade Pine Siding
- Exclusive Rough Sawn Finish
- Aesthetically Pleasing
- Tongue & Groove



BOARD & BATTEN

- 50 YEAR LIMITED WARRANTY
- Natural Wood Grain Texture
- 100% Clear
- Pre-Primed
- 50 Year Limited Warranty



DURATEMP SIDING

- 50 YEAR LIMITED WARRANTY
- Natural Wood Grain Texture
- 100% Clear
- Pre-Primed
- 50 Year Limited Warranty



SMARTSIDE SIDING

- 50 YEAR LIMITED WARRANTY
- Natural Wood Grain Texture
- 100% Clear
- Pre-Primed
- 50 Year Limited Warranty





Gable

Storage • Workshop • Gardening

OPTIONS

ON THIS 10x16

Estate Gray Dimensional Shingles

2' x 3' Windows

202TW Doors

Dark Gray / White



BASE PRICE UNIT

HOW IT'S BUILT



CONFIGURATION IDEAS



SIDING CHOICES View Pricing Guide For Current Pricing

<p>SMARTSIDE LAP SIDING</p> <p>50 YEAR LIMITED WARRANTY</p> <ul style="list-style-type: none"> Natural Wood Grain Texture 100% Clear Pre-Primed 50 Year Limited Warranty <p>LP</p>	<p>VINYL SIDING</p> <ul style="list-style-type: none"> Maintenance Free .044 Thickness Match Your Home CDX Plywood Subiding <p>ProVia HEARTTECH</p>	<p>PINE SIDING</p> <ul style="list-style-type: none"> 1 x 8 Premium Grade Pine Siding Exclusive Rough Sawn Finish Aesthetically Pleasing Tongue & Groove 	<p>BOARD & BATTEN</p> <p>50 YEAR LIMITED WARRANTY</p> <ul style="list-style-type: none"> Natural Wood Grain Texture 100% Clear Pre-Primed 50 Year Limited Warranty <p>LP</p>	<p>DURATEMP SIDING</p> <p>50 YEAR LIMITED WARRANTY</p> <ul style="list-style-type: none"> Natural Wood Grain Texture 100% Clear Pre-Primed 50 Year Limited Warranty <p>DuraTemp</p>	<p>SMARTSIDE SIDING</p> <p>50 YEAR LIMITED WARRANTY</p> <ul style="list-style-type: none"> Natural Wood Grain Texture 100% Clear Pre-Primed 50 Year Limited Warranty <p>LP</p>
--	---	---	--	---	--



Manchester

Storage • Horsebarn • Gardening

OPTIONS

ON THIS 10x14

Teak Dimensional Shingles
5' Sidewall Height
202TW Doors
Peak Extension & Bracket
Bear Beige / Bronze / Pecan



BASE PRICE UNIT HOW IT'S BUILT



CONFIGURATION IDEAS



SIDING CHOICES View Pricing Guide For Current Pricing

<p>SMARTSIDE LAP SIDING 50 YEAR LIMITED WARRANTY <ul style="list-style-type: none"> Natural Wood Grain Texture 100% Clear Pre-Primed 50 Year Limited Warranty </p>	<p>VINYL SIDING <ul style="list-style-type: none"> Maintenance Free .044 Thickness Match Your Home CDX Plywood Subiding </p>	<p>PINE SIDING <ul style="list-style-type: none"> 1 x 8 Premium Grade Pine Siding Exclusive Rough Sawn Finish Aesthetically Pleasing Tongue & Groove </p>	<p>BOARD & BATTEN 50 YEAR LIMITED WARRANTY <ul style="list-style-type: none"> Natural Wood Grain Texture 100% Clear Pre-Primed 50 Year Limited Warranty </p>	<p>DURATEMP SIDING 50 YEAR LIMITED WARRANTY <ul style="list-style-type: none"> Natural Wood Grain Texture 100% Clear Pre-Primed 50 Year Limited Warranty </p>	<p>SMARTSIDE SIDING 50 YEAR LIMITED WARRANTY <ul style="list-style-type: none"> Natural Wood Grain Texture 100% Clear Pre-Primed 50 Year Limited Warranty </p>
---	--	---	---	--	---



Sugarcreek

Storage • Pool House • Gardening

OPTIONS

ON THIS 10x16

Driftwood Dimensional Shingles

2' x 3' Windows + Transoms

102TW Doors

Navajo White Traditional Cupola

Buckskin / Navajo White / Bronze



BASE PRICE UNIT HOW IT'S BUILT



CONFIGURATION IDEAS



SIDING CHOICES View Pricing Guide For Current Pricing

<p>SMARTSIDE LAP SIDING</p> <p>50 YEAR LIMITED WARRANTY</p> <ul style="list-style-type: none"> Natural Wood Grain Texture 100% Clear Pre-Primed 50 Year Limited Warranty <p>LP</p>	<p>VINYL SIDING</p> <ul style="list-style-type: none"> Maintenance Free .044 Thickness Match Your Home CDX Plywood Subsiding <p>ProVia HEARTTECH</p>	<p>PINE SIDING</p> <ul style="list-style-type: none"> 1 x 8 Premium Grade Pine Siding Exclusive Rough Sawn Finish Aesthetically Pleasing Tongue & Groove <p></p>	<p>BOARD & BATTEN</p> <p>50 YEAR LIMITED WARRANTY</p> <ul style="list-style-type: none"> Natural Wood Grain Texture 100% Clear Pre-Primed 50 Year Limited Warranty <p>LP</p>	<p>DURATEMP SIDING</p> <p>50 YEAR LIMITED WARRANTY</p> <ul style="list-style-type: none"> Natural Wood Grain Texture 100% Clear Pre-Primed 50 Year Limited Warranty <p>DuraTemp</p>	<p>SMARTSIDE SIDING</p> <p>50 YEAR LIMITED WARRANTY</p> <ul style="list-style-type: none"> Natural Wood Grain Texture 100% Clear Pre-Primed 50 Year Limited Warranty <p>LP</p>
--	--	---	--	---	--



Craftsman

Workshop • Potting Shed • Pool House

OPTIONS

ON THIS 10x14

Driftwood Dimensional Shingles

2' x 3' Windows

202TW Doors

Flower Box / Shutter Set

Avocado / Almond / Bark



BASE PRICE UNIT HOW IT'S BUILT



CONFIGURATION IDEAS



SIDING CHOICES View Pricing Guide For Current Pricing

<p>SMARTSIDE LAP SIDING</p> <p>50 YEAR LIMITED WARRANTY</p> <ul style="list-style-type: none"> Natural Wood Grain Texture 100% Clear Pre-Primed 50 Year Limited Warranty 	<p>VINYL SIDING</p> <ul style="list-style-type: none"> Maintenance Free .044 Thickness Match Your Home CDX Plywood Subiding 	<p>PINE SIDING</p> <ul style="list-style-type: none"> 1 x 8 Premium Grade Pine Siding Exclusive Rough Sawn Finish Aesthetically Pleasing Tongue & Groove 	<p>BOARD & BATTEN</p> <p>50 YEAR LIMITED WARRANTY</p> <ul style="list-style-type: none"> Natural Wood Grain Texture 100% Clear Pre-Primed 50 Year Limited Warranty 	<p>DURATEMP SIDING</p> <p>50 YEAR LIMITED WARRANTY</p> <ul style="list-style-type: none"> Natural Wood Grain Texture 100% Clear Pre-Primed 50 Year Limited Warranty 	<p>SMARTSIDE SIDING</p> <p>50 YEAR LIMITED WARRANTY</p> <ul style="list-style-type: none"> Natural Wood Grain Texture 100% Clear Pre-Primed 50 Year Limited Warranty
--	--	---	--	---	--



Estate

Storage • Workshop • Studio

OPTIONS

ON THIS 12x16

Driftwood Dimensional Shingles
2' x 3' Windows
101SW + VERTICAL TRIM BOARD Doors
Flower Box / Shutter Set
Shale / Navajo White / Natural



BASE PRICE UNIT HOW IT'S BUILT



CONFIGURATION IDEAS



SIDING CHOICES View Pricing Guide For Current Pricing

<p>SMARTSIDE LAP SIDING</p> <p>50 YEAR LIMITED WARRANTY</p> <ul style="list-style-type: none"> Natural Wood Grain Texture 100% Clear Pre-Primed 50 Year Limited Warranty 	<p>VINYL SIDING</p> <ul style="list-style-type: none"> Maintenance Free .044 Thickness Match Your Home CDX Plywood Subiding 	<p>PINE SIDING</p> <ul style="list-style-type: none"> 1 x 8 Premium Grade Pine Siding Exclusive Rough Sawn Finish Aesthetically Pleasing Tongue & Groove 	<p>BOARD & BATTEN</p> <p>50 YEAR LIMITED WARRANTY</p> <ul style="list-style-type: none"> Natural Wood Grain Texture 100% Clear Pre-Primed 50 Year Limited Warranty 	<p>DURATEMP SIDING</p> <p>50 YEAR LIMITED WARRANTY</p> <ul style="list-style-type: none"> Natural Wood Grain Texture 100% Clear Pre-Primed 50 Year Limited Warranty 	<p>SMARTSIDE SIDING</p> <p>50 YEAR LIMITED WARRANTY</p> <ul style="list-style-type: none"> Natural Wood Grain Texture 100% Clear Pre-Primed 50 Year Limited Warranty
---	--	---	---	--	---



Woodshed

Workshop • Cabin • Pool House

OPTIONS

ON THIS 10x16
Galvalume Metal Roof
2' x 3' Windows
Shutter Set
204 SD Front Door
Ebony / Black / Chestnut Brown
Cupola



BASE PRICE UNIT HOW IT'S BUILT



CONFIGURATION IDEAS



SIDING CHOICES View Pricing Guide For Current Pricing

<p>SMARTSIDE LAP SIDING</p> <p>50 YEAR LIMITED WARRANTY</p> <ul style="list-style-type: none"> Natural Wood Grain Texture 100% Clear Pre-Primed 50 Year Limited Warranty <p>LP</p>	<p>VINYL SIDING</p> <ul style="list-style-type: none"> Maintenance Free .044 Thickness Match Your Home CDX Plywood Subsidng <p>ProVia HEARTTECH</p>	<p>PINE SIDING</p> <ul style="list-style-type: none"> 1 x 8 Premium Grade Pine Siding Exclusive Rough Sawn Finish Aesthetically Pleasing Tongue & Groove <p></p>	<p>BOARD & BATTEN</p> <p>50 YEAR LIMITED WARRANTY</p> <ul style="list-style-type: none"> Natural Wood Grain Texture 100% Clear Pre-Primed 50 Year Limited Warranty <p>LP</p>	<p>DURATEMP SIDING</p> <p>50 YEAR LIMITED WARRANTY</p> <ul style="list-style-type: none"> Natural Wood Grain Texture 100% Clear Pre-Primed 50 Year Limited Warranty <p>DuraTemp</p>	<p>SMARTSIDE SIDING</p> <p>50 YEAR LIMITED WARRANTY</p> <ul style="list-style-type: none"> Natural Wood Grain Texture 100% Clear Pre-Primed 50 Year Limited Warranty <p>LP</p>
--	---	---	--	---	--



Highland

Potting Shed • Cabin • Pool house

OPTIONS

ON THIS 10x16

Onyx Black Dimensional Shingles

2' x 4' Windows

203LW Doors

Pioneer Brown / Natural



BASE PRICE UNIT HOW IT'S BUILT



CONFIGURATION IDEAS



SIDING CHOICES View Pricing Guide For Current Pricing

<p>SMARTSIDE LAP SIDING 50 YEAR LIMITED WARRANTY • Natural Wood Grain Texture • 100% Clear • Pre-Primed • 50 Year Limited Warranty</p> 	<p>VINYL SIDING • Maintenance Free • .044 Thickness • Match Your Home • CDX Plywood Subiding</p> 	<p>PINE SIDING • 1 x 8 Premium Grade Pine Siding • Exclusive Rough Sawn Finish • Aesthetically Pleasing • Tongue & Groove</p> 	<p>BOARD & BATTEN 50 YEAR LIMITED WARRANTY • Natural Wood Grain Texture • 100% Clear • Pre-Primed • 50 Year Limited Warranty</p> 	<p>DURATEMP SIDING 50 YEAR LIMITED WARRANTY • Natural Wood Grain Texture • 100% Clear • Pre-Primed • 50 Year Limited Warranty</p> 	<p>SMARTSIDE SIDING 50 YEAR LIMITED WARRANTY • Natural Wood Grain Texture • 100% Clear • Pre-Primed • 50 Year Limited Warranty</p> 
--	---	--	--	---	--



Grand Junction

Storage • Gardening • Studio

OPTIONS

ON THIS 10x16

Estate Gray Dimensional Shingles

2' x 3' Windows

103AW Cedar Double Door

Z Strap Shutters

Square Cut Trim

Chestnut Brown / Jamestown Red / Bronze



BASE PRICE UNIT

HOW IT'S BUILT



CONFIGURATION IDEAS



SIDING CHOICES View Pricing Guide For Current Pricing

<p>SMARTSIDE LAP SIDING 50 YEAR LIMITED WARRANTY • Natural Wood Grain Texture • 100% Clear • Pre-Primed • 50 Year Limited Warranty</p> 	<p>VINYL SIDING • Maintenance Free • .044 Thickness • Match Your Home • CDX Plywood Subsiding</p> 	<p>PINE SIDING • 1 x 8 Premium Grade Pine Siding • Exclusive Rough Sawn Finish • Aesthetically Pleasing • Tongue & Groove</p> 	<p>BOARD & BATTEN 50 YEAR LIMITED WARRANTY • Natural Wood Grain Texture • 100% Clear • Pre-Primed • 50 Year Limited Warranty</p> 	<p>DURATEMP SIDING 50 YEAR LIMITED WARRANTY • Natural Wood Grain Texture • 100% Clear • Pre-Primed • 50 Year Limited Warranty</p> 	<p>SMARTSIDE SIDING 50 YEAR LIMITED WARRANTY • Natural Wood Grain Texture • 100% Clear • Pre-Primed • 50 Year Limited Warranty</p> 
--	--	--	--	---	--



Studio

Studio • Poolhouse • Gardening

OPTIONS

ON THIS 10x18
2 x 2 Windows
2 x 3 Windows
Square Cut Trim
202TW Doors

Chestnut Brown / Buckskin / Jamestown Red



BASE PRICE UNIT HOW IT'S BUILT

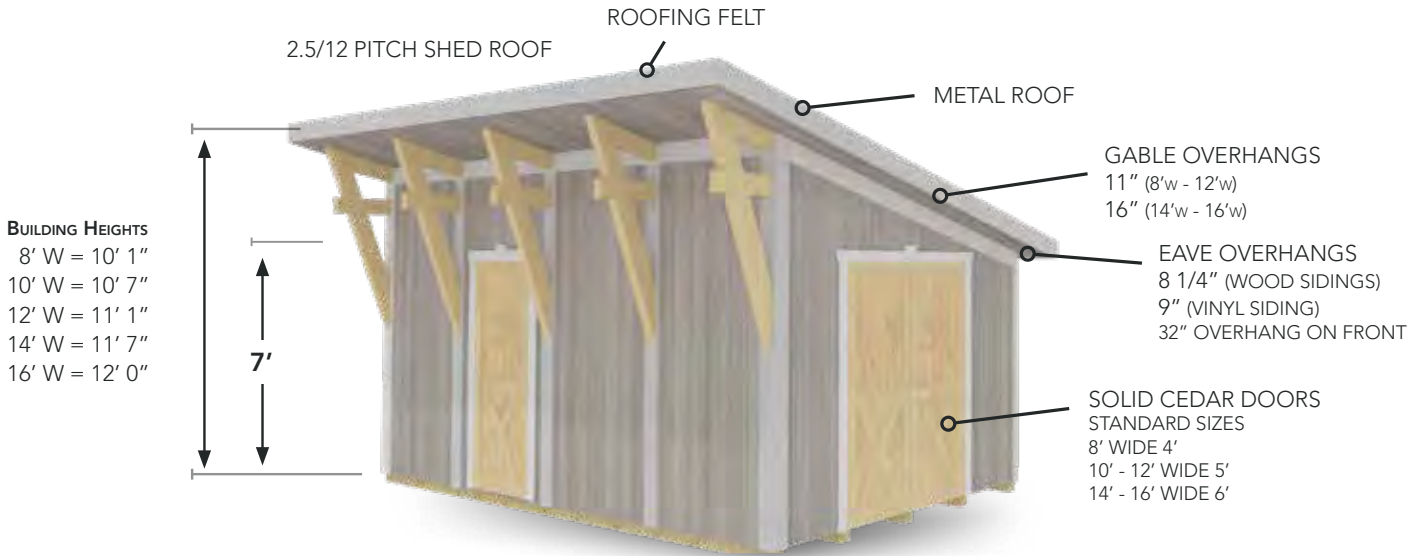

CONFIGURATION IDEAS



SIDING CHOICES View Pricing Guide For Current Pricing

<p>SMARTSIDE LAP SIDING 50 YEAR LIMITED WARRANTY</p> <ul style="list-style-type: none"> Natural Wood Grain Texture 100% Clear Pre-Primed 50 Year Limited Warranty 	<p>VINYL SIDING</p> <ul style="list-style-type: none"> Maintenance Free .044 Thickness Match Your Home CDX Plywood Subiding 	<p>PINE SIDING</p> <ul style="list-style-type: none"> 1 x 8 Premium Grade Pine Siding Exclusive Rough Sawn Finish Aesthetically Pleasing Tongue & Groove 	<p>BOARD & BATTEN 50 YEAR LIMITED WARRANTY</p> <ul style="list-style-type: none"> Natural Wood Grain Texture 100% Clear Pre-Primed 50 Year Limited Warranty 	<p>DURATEMP SIDING 50 YEAR LIMITED WARRANTY</p> <ul style="list-style-type: none"> Natural Wood Grain Texture 100% Clear Pre-Primed 50 Year Limited Warranty 	<p>SMARTSIDE SIDING 50 YEAR LIMITED WARRANTY</p> <ul style="list-style-type: none"> Natural Wood Grain Texture 100% Clear Pre-Primed 50 Year Limited Warranty
---	--	---	---	--	---



Skür

Storage • Studio • Poolhouse

OPTIONS

ON THIS 10x14
Onyz Black Dimensional Shingles
2' x 5' Windows
Square Cut Trim
204-SD Single Door (no grids)
Black / Natural



BASE PRICE UNIT HOW IT'S BUILT

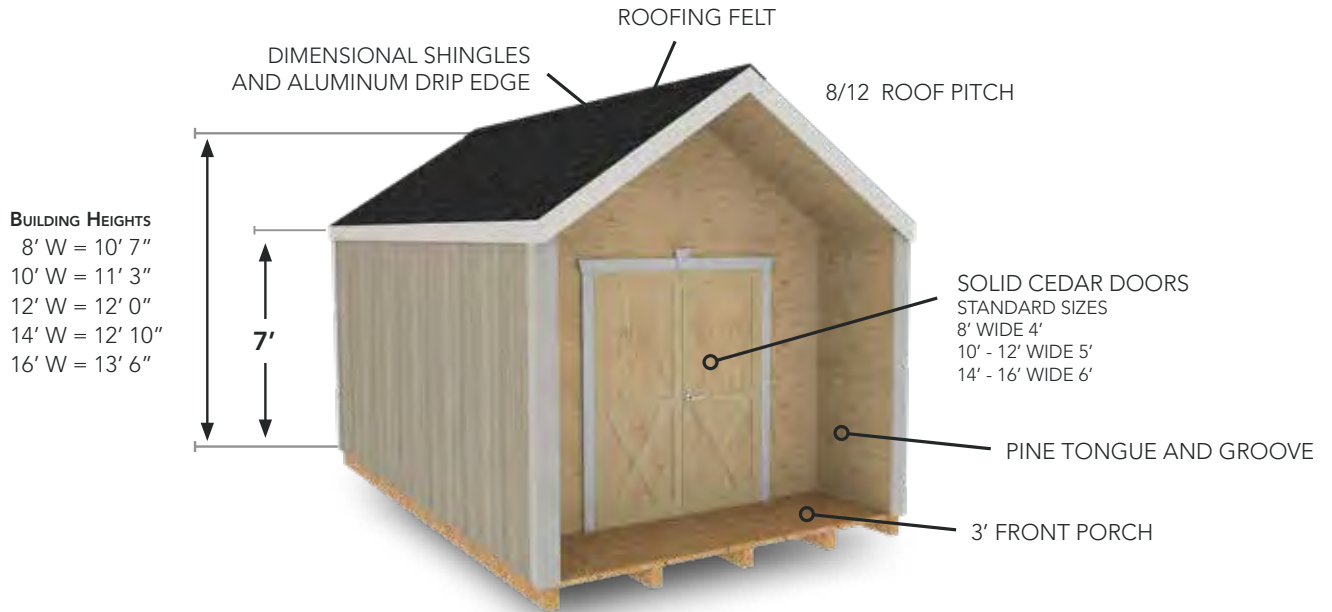

CONFIGURATION IDEAS



SIDING CHOICES View Pricing Guide For Current Pricing

<p>SMARTSIDE LAP SIDING</p> <p>50 YEAR LIMITED WARRANTY</p> <ul style="list-style-type: none"> Natural Wood Grain Texture 100% Clear Pre-Primed 50 Year Limited Warranty 	<p>VINYL SIDING</p> <ul style="list-style-type: none"> Maintenance Free .044 Thickness Match Your Home CDX Plywood Subsidng 	<p>PINE SIDING</p> <ul style="list-style-type: none"> 1 x 8 Premium Grade Pine Siding Exclusive Rough Sawn Finish Aesthetically Pleasing Tongue & Groove 	<p>BOARD & BATTEN</p> <p>50 YEAR LIMITED WARRANTY</p> <ul style="list-style-type: none"> Natural Wood Grain Texture 100% Clear Pre-Primed 50 Year Limited Warranty 	<p>DURATEMP SIDING</p> <p>50 YEAR LIMITED WARRANTY</p> <ul style="list-style-type: none"> Natural Wood Grain Texture 100% Clear Pre-Primed 50 Year Limited Warranty 	<p>SMARTSIDE SIDING</p> <p>50 YEAR LIMITED WARRANTY</p> <ul style="list-style-type: none"> Natural Wood Grain Texture 100% Clear Pre-Primed 50 Year Limited Warranty
--	--	---	--	---	--



Easton

Studio • Office • Storage

OPTIONS

ON THIS 10x20

Black Metal Roofing

204-FW 6' x 6'8" Doors (no grids)

2' x 5' Windows

Square Cut Trim

Bronze / Jamestown Red / Buckskin / Black



BASE PRICE UNIT HOW IT'S BUILT



CONFIGURATION IDEAS



SIDING CHOICES View Pricing Guide For Current Pricing

<p>SMARTSIDE LAP SIDING 50 YEAR LIMITED WARRANTY</p> <ul style="list-style-type: none"> Natural Wood Grain Texture 100% Clear Pre-Primed 50 Year Limited Warranty 	<p>VINYL SIDING</p> <ul style="list-style-type: none"> Maintenance Free .044 Thickness Match Your Home CDX Plywood Subsidng 	<p>PINE SIDING</p> <ul style="list-style-type: none"> 1 x 8 Premium Grade Pine Siding Exclusive Rough Sawn Finish Aesthetically Pleasing Tongue & Groove 	<p>BOARD & BATTEN 50 YEAR LIMITED WARRANTY</p> <ul style="list-style-type: none"> Natural Wood Grain Texture 100% Clear Pre-Primed 50 Year Limited Warranty 	<p>DURATEMP SIDING 50 YEAR LIMITED WARRANTY</p> <ul style="list-style-type: none"> Natural Wood Grain Texture 100% Clear Pre-Primed 50 Year Limited Warranty 	<p>SMARTSIDE SIDING 50 YEAR LIMITED WARRANTY</p> <ul style="list-style-type: none"> Natural Wood Grain Texture 100% Clear Pre-Primed 50 Year Limited Warranty
--	--	---	--	---	--



Shed Addition

Storage • Gardening

OPTIONS

ON THIS 4x8
Pictured: 12x18 Gable
Jamestown Red



BASE PRICE UNIT

HOW IT'S BUILT

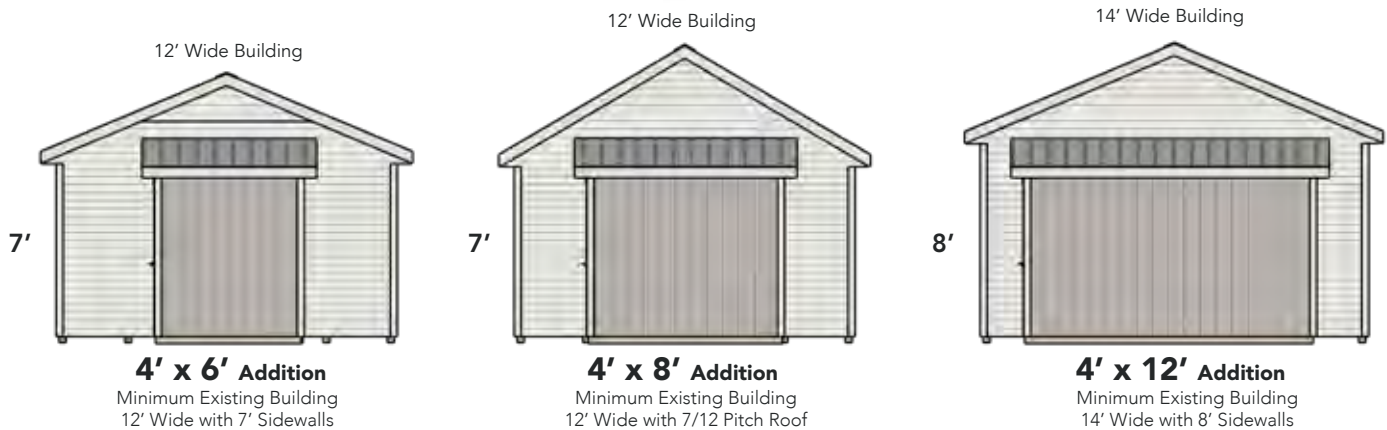

SIDING CHOICES View Pricing Guide For Current Pricing

<p>SMARTSIDE LAP SIDING</p> <p>50 YEAR LIMITED WARRANTY</p> <ul style="list-style-type: none"> Natural Wood Grain Texture 100% Clear Pre-Primed 50 Year Limited Warranty 	<p>VINYL SIDING</p> <ul style="list-style-type: none"> Maintenance Free .044 Thickness Match Your Home CDX Plywood Subsiding 	<p>PINE SIDING</p> <ul style="list-style-type: none"> 1 x 8 Premium Grade Pine Siding Exclusive Rough Sawn Finish Aesthetically Pleasing Tongue & Groove 	<p>BOARD & BATTEN</p> <p>50 YEAR LIMITED WARRANTY</p> <ul style="list-style-type: none"> Natural Wood Grain Texture 100% Clear Pre-Primed 50 Year Limited Warranty 	<p>DURATEMP SIDING</p> <p>50 YEAR LIMITED WARRANTY</p> <ul style="list-style-type: none"> Natural Wood Grain Texture 100% Clear Pre-Primed 50 Year Limited Warranty 	<p>SMARTSIDE SIDING</p> <p>50 YEAR LIMITED WARRANTY</p> <ul style="list-style-type: none"> Natural Wood Grain Texture 100% Clear Pre-Primed 50 Year Limited Warranty
---	---	---	---	--	---

TBASICS

STANDARD ON BACKYARD BASICS SHEDS

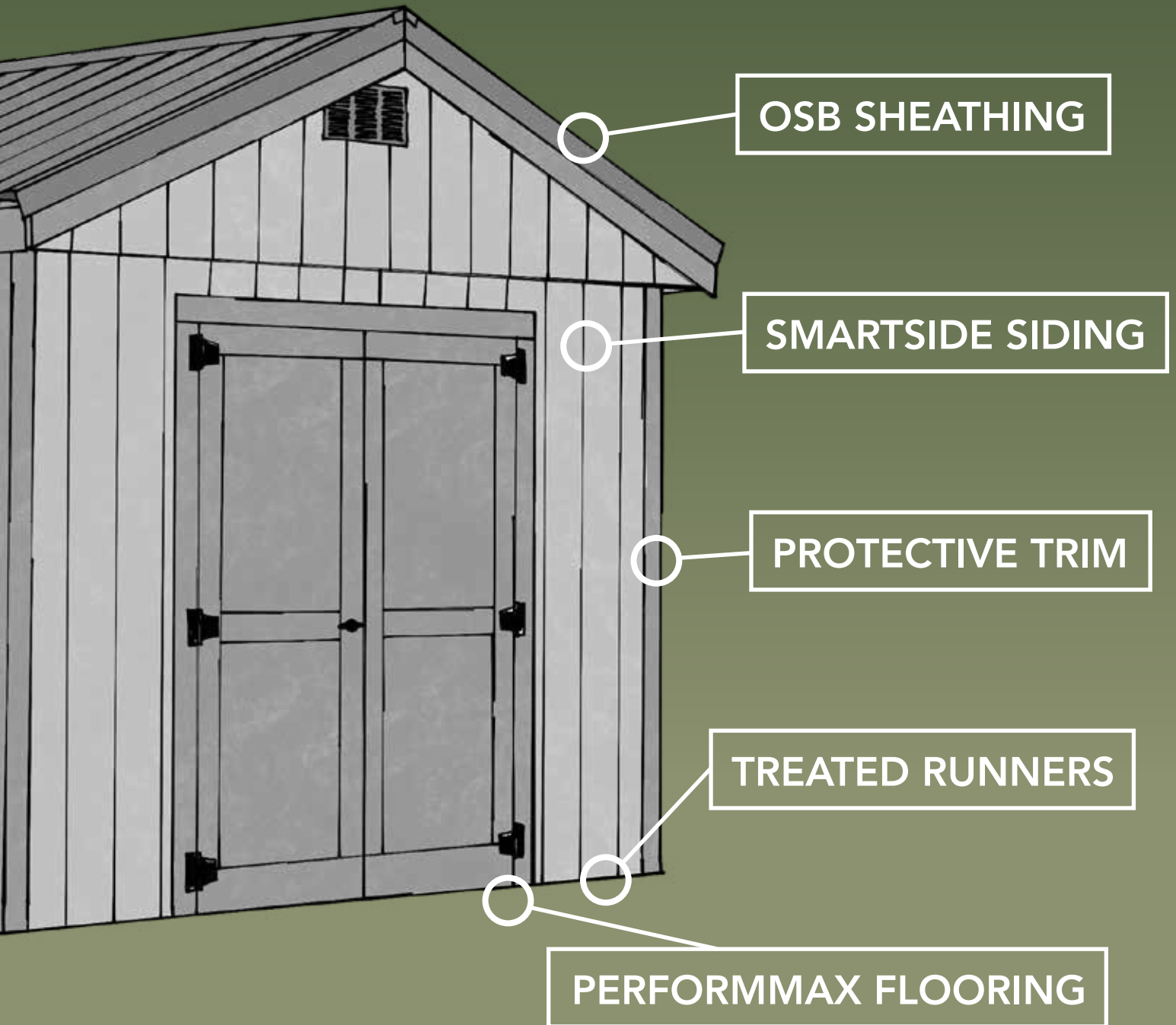

BACKYARD BASICS

Simple is sometimes better. At Weaver Barns, we decided to take this principle and turn it into our BACKYARD BASICS. Using our core models, we created this new line that focuses on simplicity.

2 YEAR LIMITED WARRANTY

The first model, the JACKSON, features a classic gable-style roof. We created this design with a focus on functionality and simplicity. This model is a fantastic option for those in search of a storage space or workshop.

If you're looking for a reliable and spacious storage solution, the NEW HAVEN is an excellent option. With its classic roof design, this structure will be a standout addition to your property and will impress anyone who sees it.

Our third model, the ADDISON, stands out with its clean lines and modern shed roof. This design makes the perfect pool house, studio, or garden shed!

Our fourth and last design in this collection is the CAMDEN. This classic-style pavilion will make your backyard the envy of the neighborhood with its simple yet classic elegance.



SIMPLICITY BUILT RIGHT



Jackson

OPTIONS

ON THIS 10x14
 Bronze Metal Roofing
 #200 5' Double Doors
 Square Cut Trim
 Smoke / Bronze

BASE PRICE UNIT

HOW IT'S BUILT

BUILDING HEIGHTS

- 8' W = 9' 8"
- 10' W = 10' 1"
- 12' W = 10' 6"
- 14' W = 11' 1"
- 16' W = 11' 6"





Addison

OPTIONS

ON THIS 10x12
 Black Metal Roofing
 #202-TW 5' Double Doors
 Square Cut Trim
 Pioneer / Ebony

BASE PRICE UNIT HOW IT'S BUILT





New Haven

OPTIONS

ON THIS 10x14
 Driftwood Shingles
 #200 5' Double Doors
 2x3 Windows
 Square Cut Trim
 Khaki / Navajo White / Bronze

BASE PRICE UNIT

HOW IT'S BUILT

BUILDING HEIGHTS

- 8' W = 10' 3"
- 10' W = 11'
- 12' W = 11' 9"
- 14' W = 12' 6"
- 16' W = 13' 3"





Camden

OPTIONS

ON THIS 12x14
 Black Dimensional Shingles
 Clay

SIZES & POST LAYOUTS



SIZES IN THIS CONFIGURATION

10x10	12x14
10x12	12x16
10x16	14x14
12x12	14x16

SPECIFICATIONS

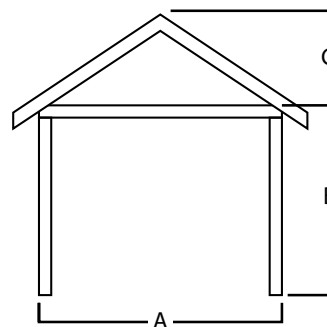

A	B	C
10'	7'4"	10' 2"
12'	7'4"	10' 7"
14'	7'4"	11' 0"



BACKYARD LIVING





OPTIONS
ON THIS 12x12
• Smoke

Laredo

Bold big timbers and elegant accents make the LAREDO pergola a perfect addition to your outdoor living space. For extra wow factor add it to a pavilion and create a duel zone outdoor entertainment area.

HOW ITS MADE

Solid Cedar 8x8 Posts
Solid Cedar Beams
Solid Cedar Roof Slats

SIZES & POST LAYOUTS



SIZES IN THIS CONFIGURATION

10x10	12x16
10x12	14x14
10x16	14x16
12x12	16x16
12x14	

SPECIFICATIONS

width	A
10'	8'
12'	8'
14'	8'
16'	8'



OPTIONS

ON THIS 12x16

- Driftwood Stain
- Bronze Metal Roof

Timber Ridge

Available In Solid Pine Or Cedar

Beautiful Timber Framing in a timeless design makes the TIMBER RIDGE Pavilion perfect in any setting. Large rustic solid wood beams and solid wood rafters defines the style and quality of this beautiful structure.

BASE PRICE MODEL STANDARD FEATURES

Rough Sawn Solid 8x8 Post's
Rough Sawn Solid Carrier Beams
Rough Sawn Solid Timber Frame
style Gables
Y-Support Bracing
8/12 Pitch Roof
Minimum 4x6 Rafter's 24" O.C.
1x8 Tongue and Groove ceiling
CDX Plywood Roof Sheathing
Aluminum Drip Edge
Dimensional Shingles

BRACKET CHOICES

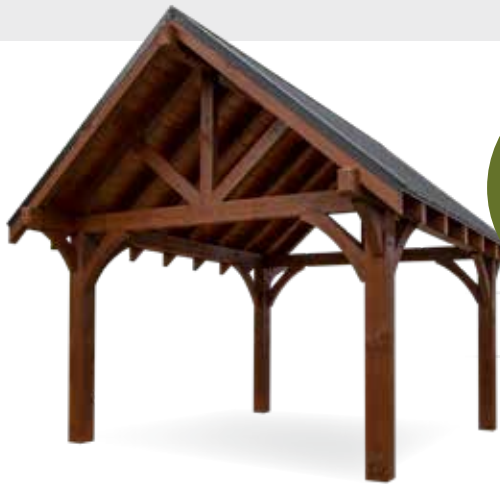

CURVED



STRAIGHT

SIZES & POST LAYOUTS



SIZES IN THIS CONFIGURATION

10x10 12x14 16x16
 10x12 12x16
 10x16 14x14
 12x12 14x16



SIZES IN THIS CONFIGURATION

12x20 14x28
 12x24 16x20
 14x20
 14x24



SIZES IN THIS CONFIGURATION

14x32 20x20
 16x24 20x24
 16x28 20x28
 16x32

SPECIFICATIONS

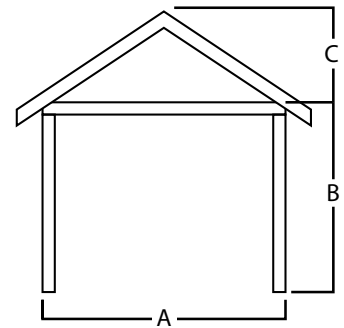

A	B	C
10'	8'	11' 10"
12'	8'	12' 6"
14'	8'	13' 4"
16'	8'	14'
20'	8'	15' 7"



OPTIONS

ON THIS 12x16

- Pecan
- Driftwood Dimensional Shingles



Bradford

Available In Solid Pine Or Cedar

With bold rustic rough sawn beams and a classic hip roof, the BRADFORD is timeless in its design. A wonderful addition to a backyard or a pool side, you will love this beautiful structure.

BASE PRICE MODEL
STANDARD FEATURES

- Rough Sawn Solid 8x8 Post's
- Rough Sawn Solid Carrier Beams
- Y-Support Bracing
- 7/12 Roof Pitch
- Minimum 4x6 Rafter's 24" O.C.
- 1x8 Tongue and Groove ceiling
- CDX Plywood Roof Sheathing
- Aluminum Drip Edge
- Dimensional Shingles

BRACKET CHOICES



CURVED



STRAIGHT

SIZES & POST LAYOUTS



SIZES IN THIS CONFIGURATION

10x10 12x14 16x16
 10x12 12x16
 10x16 14x14
 12x12 14x16



SIZES IN THIS CONFIGURATION

12x20 14x32
 12x24 16x20
 14x20 16x24
 14x24 16x28
 14x28 16x32



SIZES IN THIS CONFIGURATION

20x20
 20x24
 20x28
 20x32

SPECIFICATIONS

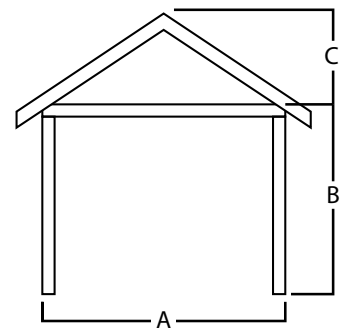

A	B	C
10'	8'	11' 6"
12'	8'	12' 1"
14'	8'	12' 10"
16'	8'	13' 5"
20'	8'	14' 9"



OPTIONS

ON THIS 12x16

- Bronze Metal Roofing
- Natural / Chestnut Brown



Lakewood

Available In Solid Pine Or Cedar

Mixing classic timber construction with a contemporary one sided roof makes the LAKEWOOD one of a kind. A standard open concept makes this pavilion perfect for you to enjoy with your friends and family.

BASE PRICE MODEL STANDARD FEATURES

- Rough Sawn Solid 8x8 Post's
- Rough Sawn Solid Carrier Beams
- Y-Support Bracing
- 2/12 Roof Pitch
- Minimum 4x6 Rafter's 24" O.C.
- 1x8 Tongue and Groove ceiling
- CDX Plywood Roof Sheathing
- Steel Drip Edge
- Metal Roof
- 1' Overhang

STRUCTURE OPTIONS

OPEN BACK
STANDARD MODEL



CLOSED CEILING
5% UPCHARGE



BACK & SIDE WALLS
OPTIONAL WITH UPCHARGE



SIZES & POST LAYOUTS



SIZES IN THIS CONFIGURATION

12x14
12x16
12x18
14x16
14x18



SIZES IN THIS CONFIGURATION

12x24
12x28
14x24
14x26
14x30

SPECIFICATIONS

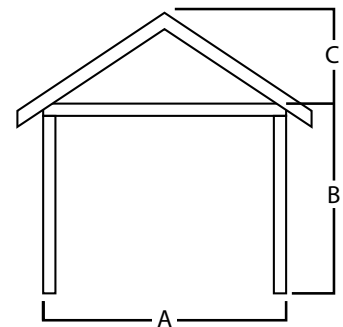

A	B	C
10'	7' 4"	10' 4"
12'	7' 4"	10' 9"
14'	7' 4"	11' 2"
16'	7' 4"	11' 7"



OPTIONS

ON THIS 12x16

- Solid Pine Stained Smoke / Natural
- Bronze Metal Roof

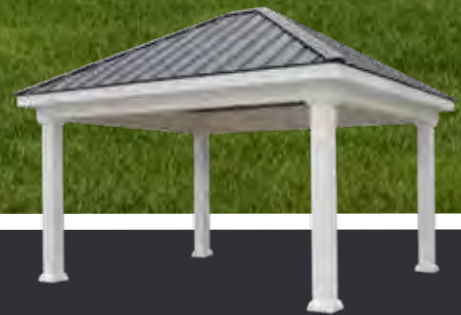

Dublin

Available In Pine, Cedar & Vinyl

Everyone loves beautiful outdoor spaces. The DUBLIN with its clean flush ceiling, exposed post and beam detail and low maintenance construction option, makes it the perfect structure to make a statement in your backyard. Personalize it with beautiful bracket choices.

BASE PRICE MODEL
STANDARD FEATURES (VINYL)

- Vinyl Wrapped 8x8 Post's
- Cellular PVC Wrapped Carrier Beams
- Cellular PVC Soffit & Fascia
- 7/12 Roof Pitch
- 2x6 Rafter's 24" O.C.
- 1x8 Tongue and Groove ceiling
- CDX Plywood Roof Sheathing
- Aluminum Drip Edge
- Dimensional Shingles

VINYL BRACKET CHOICES



CURVED

*ADDITIONAL COST
(VINYL ONLY)



ARCHED

*ADDITIONAL COST
(VINYL ONLY)

VINYL SIZES & POST LAYOUTS



4 POST

SIZES IN THIS CONFIGURATION

10x10 12x14 16x16
10x12 12x16 20x20
10x16 14x14
12x12 14x16



6 POST

SIZES IN THIS CONFIGURATION

12x20 16x24
12x24 16x28
14x20 16x32
14x24 20x24
14x28 20x28
14x32 20x32
16x20

SPECIFICATIONS

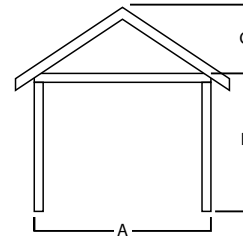

VINYL

WOOD

A	B	C
10'	9'	12' 3"
12'	9'	13' 1"
14'	9'	13' 8"
16'	9'	14' 3"
20'	9'	15' 5"

A	B	C
10'	8'	11' 8"
12'	8'	12' 5"
14'	8'	13'
16'	8'	13' 9"
20'	8'	14' 11"

WOOD SIZES & POST LAYOUTS



4 POST

SIZES IN THIS CONFIGURATION

10x10 12x14 16x16
10x12 12x16
10x16 14x14
12x12 14x16



6 POST

SIZES IN THIS CONFIGURATION

12x20 14x32
12x24 16x20
14x20 16x24
14x24 16x28
14x28 16x32



8 POST

SIZES IN THIS CONFIGURATION

20x20
20x24
20x28
20x32

POST OPTIONS

Add accents to your wood post structures or change post colors on a vinyl structure

WOOD POST OPTIONS



STANDARD
WOOD
POST



OPTIONAL
SMOOTH
PINE
*LIMITED
COLORS



OPTIONAL
BASE
WOOD
ACCENT

VINYL POST OPTIONS



STANDARD
WHITE
VINYL
SLEEVE



OPTIONAL
CLAY
VINYL
SLEEVE

WOOD BASE ACCENT



3' POST WRAP



INSTALLATION METHODS

DURA COLUMN POST SYSTEM

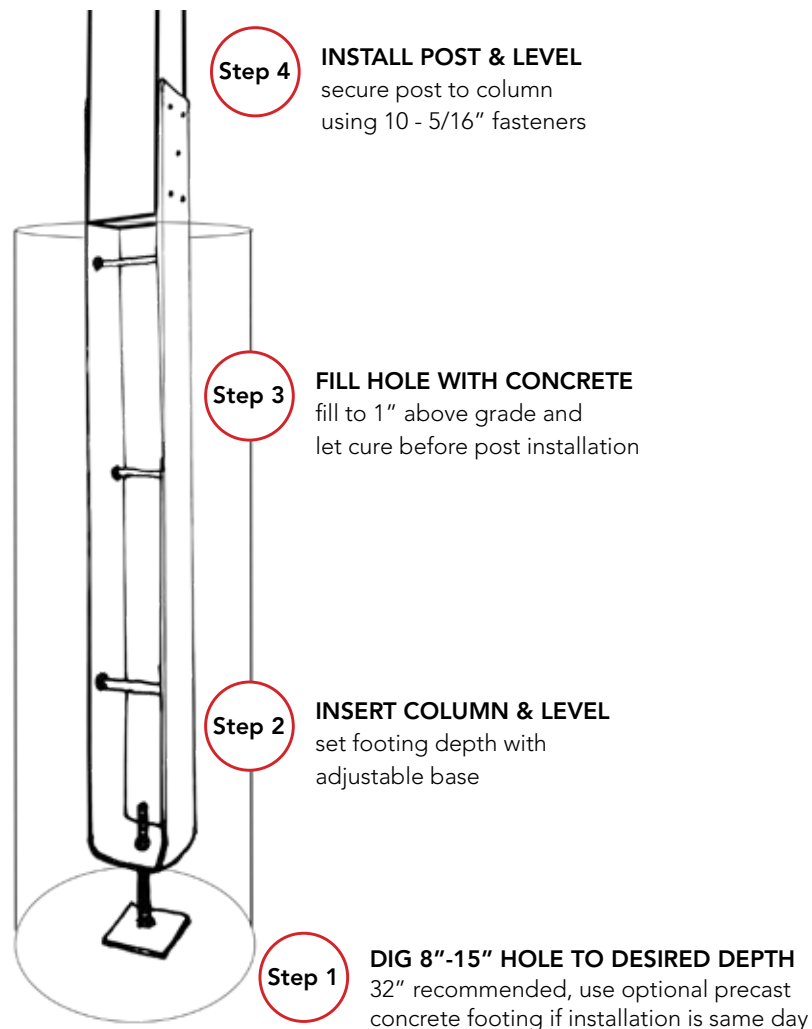

METAL POST ANCHOR

POST ABOVE GRADE

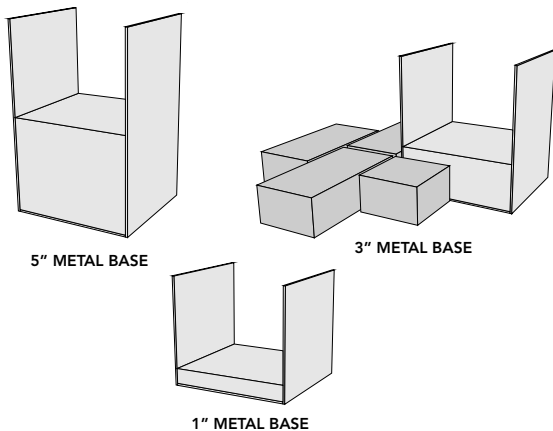

OUR INCLUDED INSTALLATION METHOD

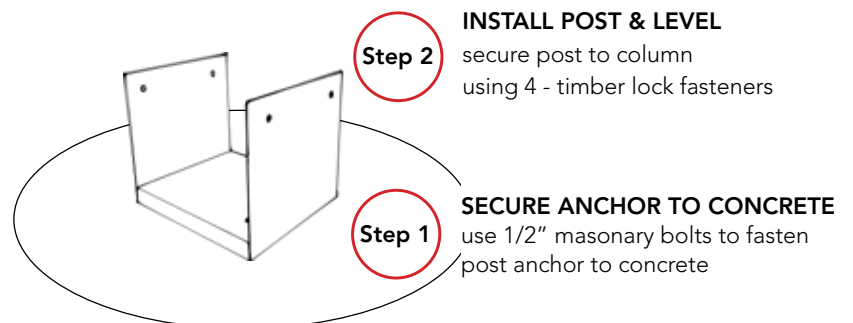

GARAGES

Looking For A Garage? Discover The Process.

Step 1 - Size?

WHAT SIZE DO I NEED?

The first step in your design journey begins with size. What will you need to store, and what would you like to do with the space. Answering these questions early will save you time, money, and energy.

Layout Size Ideas

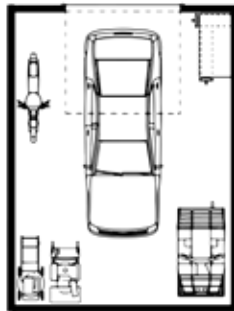

18x24 ONE CAR 432 Sq. Ft.

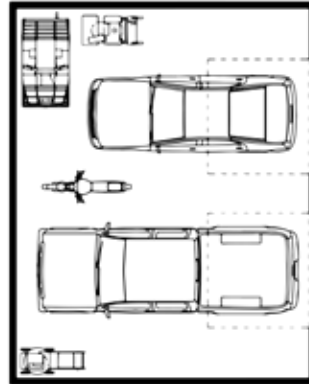

24x30 TWO CAR 720 Sq. Ft.

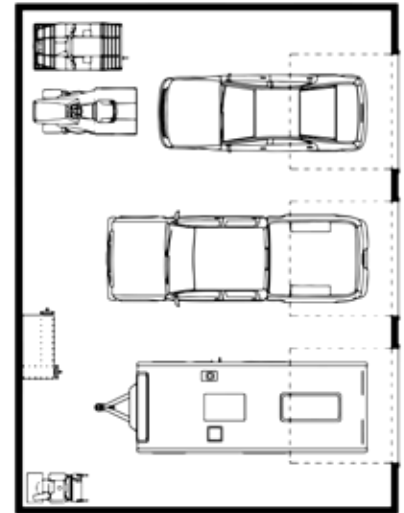

30x40 THREE CAR 1200 Sq. Ft.

Step 2 - Design?



NOT THE LOOK YOU WANT?

All of our models are base designs. We fully expect you to design the project to your ideas. Use our models as a basic concept, but don't limit yourself. We are a full custom builder. You dream it, we build it.

Step 3 - Foundation Type?

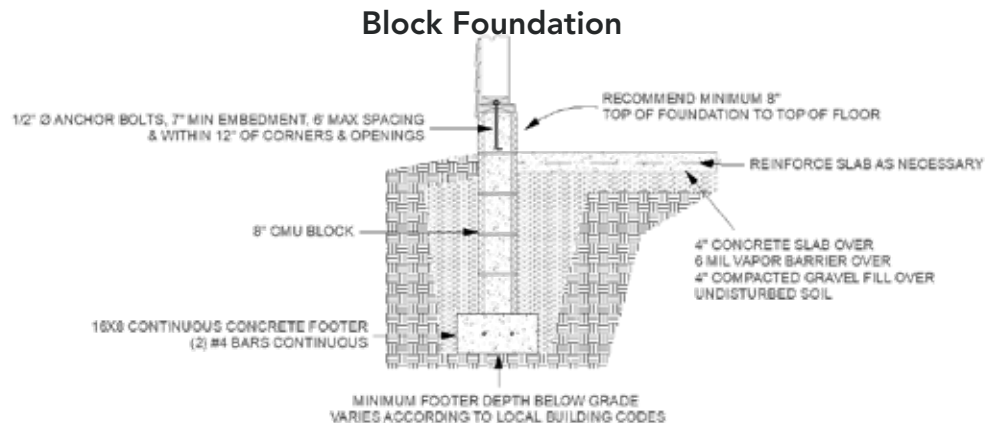

Mono Pour Foundation

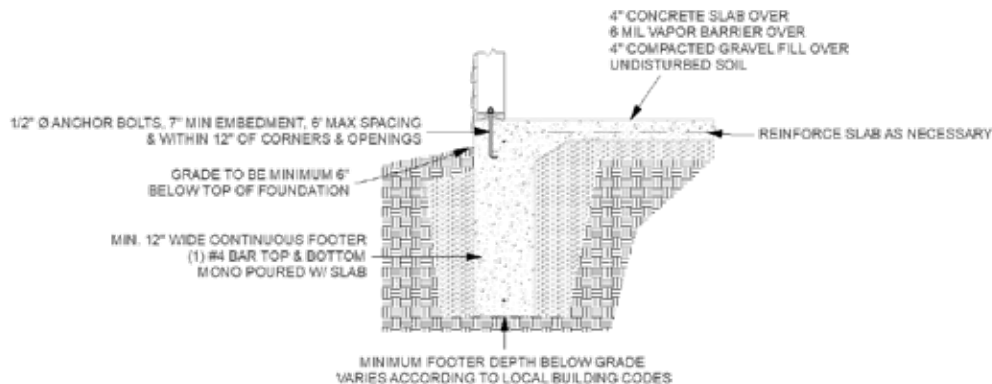

Step 4 - Permits?

Weaver Barns builds in several different States. We ask the customer to be involved and pull the permits on projects that require that. We can provide the permit drawings and technical details required. Not all projects require permits, please inquire with local building, zoning, HOAs or any regulatory agency in your area.



Step 5 - Construction?

Once you have these steps completed, you will be ready for construction to begin. Our team will help guide you throughout this process, and make it as smooth as possible. Remember, it is construction. Variables are to be expected. Things like weather can play a large role in meeting project milestones. We do our best to be as efficient as possible.





Gable Garage

Garage • Storage • Workshop

OPTIONS

ON THIS 12x20

2x4 Windows

Teak Dimensional Shingles

Chestnut Brown / Buckskin

Windows in Garage Door

Gable Garage



BASE PRICE UNIT

HOW IT'S BUILT

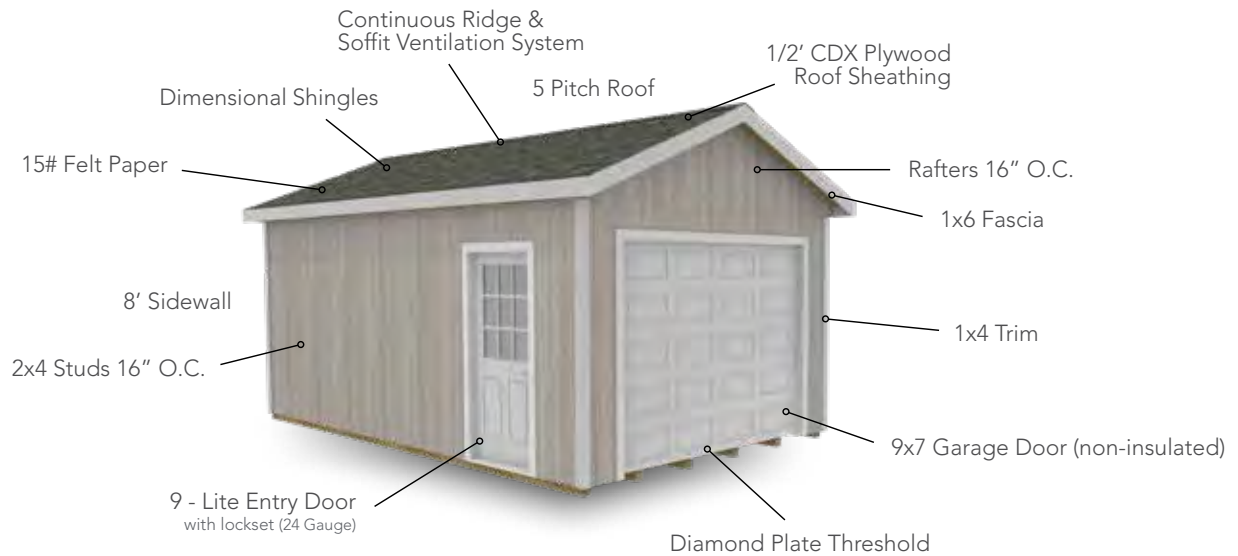

INFORMATION

*free delivery for 30 miles, delivery charges may apply beyond 30 Miles

BUILDING HEIGHTS

12' Wide = 11' 7" High
 14' Wide = 12' 0" High
 16' Wide = 12' 5" High



SIDING CHOICES [View Pricing Guide For Current Pricing](#)

<p>SMARTSIDE LAP SIDING</p> <p>50 YEAR LIMITED WARRANTY</p> <ul style="list-style-type: none"> Natural Wood Grain Texture 100% Clear Pre-Primed 50 Year Limited Warranty <p>LP</p>	<p>VINYL SIDING</p> <ul style="list-style-type: none"> Maintenance Free .044 Thickness Match Your Home CDX Plywood Subsidizing <p>ProVia HEARTTECH</p>	<p>PINE SIDING</p> <ul style="list-style-type: none"> 1 x 8 Premium Grade Pine Siding Exclusive Rough Sawn Finish Aesthetically Pleasing Tongue & Groove <p>LP</p>	<p>BOARD & BATTEN</p> <p>50 YEAR LIMITED WARRANTY</p> <ul style="list-style-type: none"> Natural Wood Grain Texture 100% Clear Pre-Primed 50 Year Limited Warranty <p>LP</p>	<p>DURATEMP SIDING</p> <p>50 YEAR LIMITED WARRANTY</p> <ul style="list-style-type: none"> Natural Wood Grain Texture 100% Clear Pre-Primed 50 Year Limited Warranty <p>DuraTemp</p>	<p>SMARTSIDE SIDING</p> <p>50 YEAR LIMITED WARRANTY</p> <ul style="list-style-type: none"> Natural Wood Grain Texture 100% Clear Pre-Primed 50 Year Limited Warranty <p>LP</p>
--	--	--	--	---	--

Workshop

OPTIONS ON THIS 18x24

- 12 x 7 Carriage House Door
- 2' x 4' Aluminum Windows
- Driftwood Shingles
- Natural Cedar Shakes
- Windows In Garage Door
- Painted Clay / White
- Timber Frame Bracket



WORKSHOP ESTIMATE MATRIX



Basic

- Size: 16 x 20
- Painted Smartside Siding
- 1 - 12 x 7 Insulated Garage Doors
- 1 - 6 Panel Steel Door
- 30 Year Shingle Roof
- Timber Frame Bracket
- 8' Walls

Estimated Price **\$20,900**
+ Foundation & Concrete \$5,200 - \$12,000



Deluxe

- Size: 18 x 24
- Painted Smartside Siding
- 1 - 12 x 7 Insulated Garage Doors
- 1 - 6 Panel Steel Door
- 30 Year Shingle Roof
- Timber Frame Bracket
- 8' Walls
- 2x4 Aluminum Window
- Cedar Shakes

Estimated Price **\$25,600**
+ Foundation & Concrete \$7,000 - \$19,000



Ultimate

- Size: 20 x 32
- Painted LP Lap Siding
- 1 - 12 x 7 Carriage Garage Doors
- 1 - 9 Light Steel Door
- Metal Roof
- Cupola
- Timber Frame Bracket
- 2x4 + Transom Aluminum Windows
- Door Awning + Arbor

Estimated Price **\$41,600**
+ Foundation & Concrete \$11,000 - \$15,000



BASE PRICE UNIT

HOW IT'S BUILT

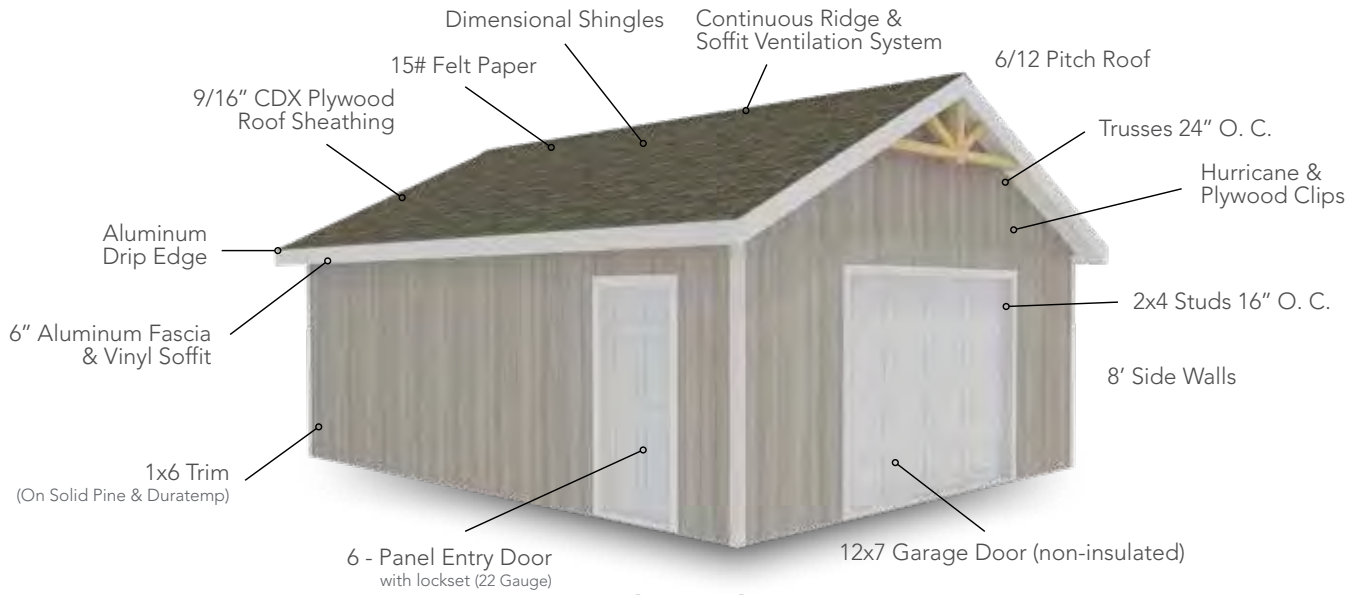

INFORMATION

*free delivery for 30 miles, delivery charges may apply beyond 30 Miles

The Workshop is real property No additional sales tax charged

Floor is not included

BUILDING HEIGHTS

16' Wide = 12' 6" High
 18' Wide = 13' 0" High
 20' Wide = 13' 6" High



SIDING CHOICES [View Pricing Guide For Current Pricing](#)

<p>SMARTSIDE LAP SIDING</p> <p>50 YEAR LIMITED WARRANTY</p> <ul style="list-style-type: none"> Natural Wood Grain Texture 100% Clear Pre-Primed 50 Year Limited Warranty 	<p>VINYL SIDING</p> <ul style="list-style-type: none"> Maintenance Free .044 Thickness Match Your Home CDX Plywood Subsidizing 	<p>PINE SIDING</p> <ul style="list-style-type: none"> 1 x 8 Premium Grade Pine Siding Exclusive Rough Sawn Finish Aesthetically Pleasing Tongue & Groove 	<p>BOARD & BATTEN</p> <p>50 YEAR LIMITED WARRANTY</p> <ul style="list-style-type: none"> Natural Wood Grain Texture 100% Clear Pre-Primed 50 Year Limited Warranty 	<p>DURATEMP SIDING</p> <p>50 YEAR LIMITED WARRANTY</p> <ul style="list-style-type: none"> Natural Wood Grain Texture 100% Clear Pre-Primed 50 Year Limited Warranty 	<p>SMARTSIDE SIDING</p> <p>50 YEAR LIMITED WARRANTY</p> <ul style="list-style-type: none"> Natural Wood Grain Texture 100% Clear Pre-Primed 50 Year Limited Warranty
---	---	---	---	--	---

The Classic

OPTIONS ON THIS 24x32

- Estate Gray Dimensional Shingles
- Custom Cupola
- 16 x 7 Carriage House Door
- 3' x 4' Vinyl Windows
- Vinyl Shutters
- Gutters and Downspouts
- Windows In Garage Door
- Pewter / White



CLASSIC ESTIMATE MATRIX



Two Car Basic

- Size: 24 x 24
- Painted Smartside Siding
- 2 - 9 x 7 Uninsulated Garage Doors
- 1 - 9 Light Steel Door
- Dimensional Shingle Roof
- 8' Walls

Estimated Price **\$26,900**
+ Foundation & Concrete \$9,000 - \$14,500



Two Car Deluxe

- Size: 24 x 24
- Vinyl Siding
- 2 - 9 x 7 Insulated Carriage Doors
- 2 - 3 x 4 Vinyl Window
- 1 - 9 Light Steel Door
- Dimensional Shingle Roof
- 8' Walls
- 7/12 Pitch Roof Upgrade

Estimated Price **\$34,100**
+ Foundation & Concrete \$9,000 - \$14,000



Three Car Deluxe

- Size: 24 x 36
- Vinyl Siding
- 3- 9 x 7 Insulated Carriage Doors
- 4 - 3 x 4 Vinyl Window
- 1 - 9 Light Steel Door
- Dimensional Shingle Roof
- 9' Walls
- 8/12 Pitch Roof Upgrade

Estimated Price **\$49,900**
+ Foundation & Concrete \$12,000 - \$19,000

The Classic

Garages



BASE PRICE UNIT

HOW IT'S BUILT

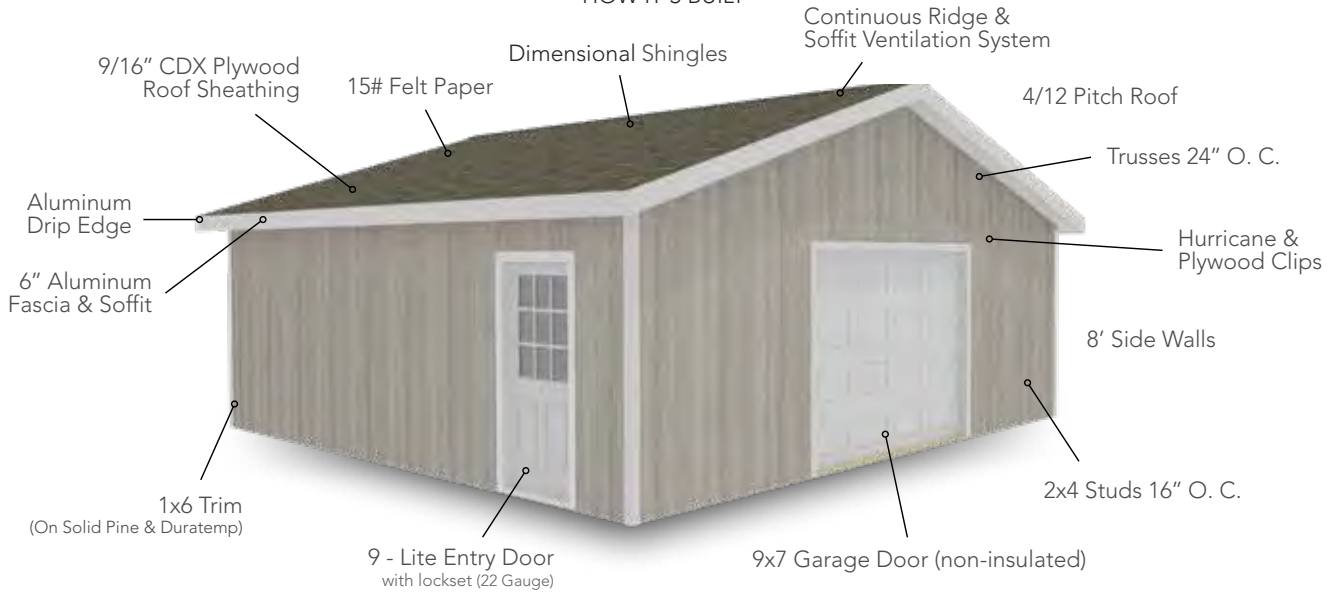

INFORMATION

*free delivery for 30 miles, delivery charges may apply beyond 30 Miles

The Classic is real property No additional sales tax charged

Floor is not included

BUILDING HEIGHTS

24' Wide = 12' 5" High
30' Wide = 13' 5" High



SIDING CHOICES [View Pricing Guide For Current Pricing](#)

SMARTSIDE LAP SIDING

- 50 YEAR LIMITED WARRANTY**
- Natural Wood Grain Texture
 - 100% Clear
 - Pre-Primed
 - 50 Year Limited Warranty



VINYL SIDING

- Maintenance Free
- .044 Thickness
- Match Your Home
- CDX Plywood Subsidizing



PINE SIDING

- 1 x 8 Premium Grade Pine Siding
- Exclusive Rough Sawn Finish
- Aesthetically Pleasing
- Tongue & Groove



BOARD & BATTEN

- 50 YEAR LIMITED WARRANTY**
- Natural Wood Grain Texture
 - 100% Clear
 - Pre-Primed
 - 50 Year Limited Warranty



DURATEMP SIDING

- 50 YEAR LIMITED WARRANTY**
- Natural Wood Grain Texture
 - 100% Clear
 - Pre-Primed
 - 50 Year Limited Warranty



SMARTSIDE SIDING

- 50 YEAR LIMITED WARRANTY**
- Natural Wood Grain Texture
 - 100% Clear
 - Pre-Primed
 - 50 Year Limited Warranty



Heritage

OPTIONS ON THIS 24x36

- Custom Cupola
- 9 x 9 Carriage House OHD
- 10' Walls
- Custom Window Package
- Painted Steel Entry Door
- Metal Roof Charcoal
- Full Length Awning
- Windows In Garage Door
- Jamestown Red / Clay



HERITAGE ESTIMATE MATRIX



Two Car Basic

- Size: 24 x 24
- Painted Smartside Siding
- 2 - 9 x 7 Insulated Garage Doors
- 1 - 9 Light Steel Door
- Dimensional Shingle Roof
- 9' Walls
- Full Attic with Attic Pull Down Steps

Estimated Price **\$38,900**
 + Foundation & Concrete \$9,000 - \$14,000



Two Car Deluxe

- Size: 24 x 28
- Painted Smartside Siding
- 2 - 9 x 7 Insulated Carriage Doors
- 3 - 2 x 4 with Transom Above
- 3 - 2 x 3 Aluminum Windows
- 1 - 9 Light Steel Door
- Metal Roof
- 9' Walls
- Full Attic With Steps And Landing
- Stone Accents & Open Rafter Awnings

Estimated Price **\$53,900**
 + Foundation & Concrete \$12,000 - \$16,000



Three Car Deluxe

- Size: 24 x 36
- Painted Duratemp Siding
- 2 - 9 x 7 Insulated Carriage Doors
- 4 - 2 x 4 with Transom Above
- 3 - 2 x 3 Aluminum Windows
- 1 - 9 Light Steel Door
- Metal Roof - with Cupola & Weathervane
- 9' Walls
- Full Attic With Steps And Landing
- Stone Accents & Open Rafter Awnings

Estimated Price **\$64,700**
 + Foundation & Concrete \$13,000 - \$19,000



BASE PRICE UNIT

HOW IT'S BUILT

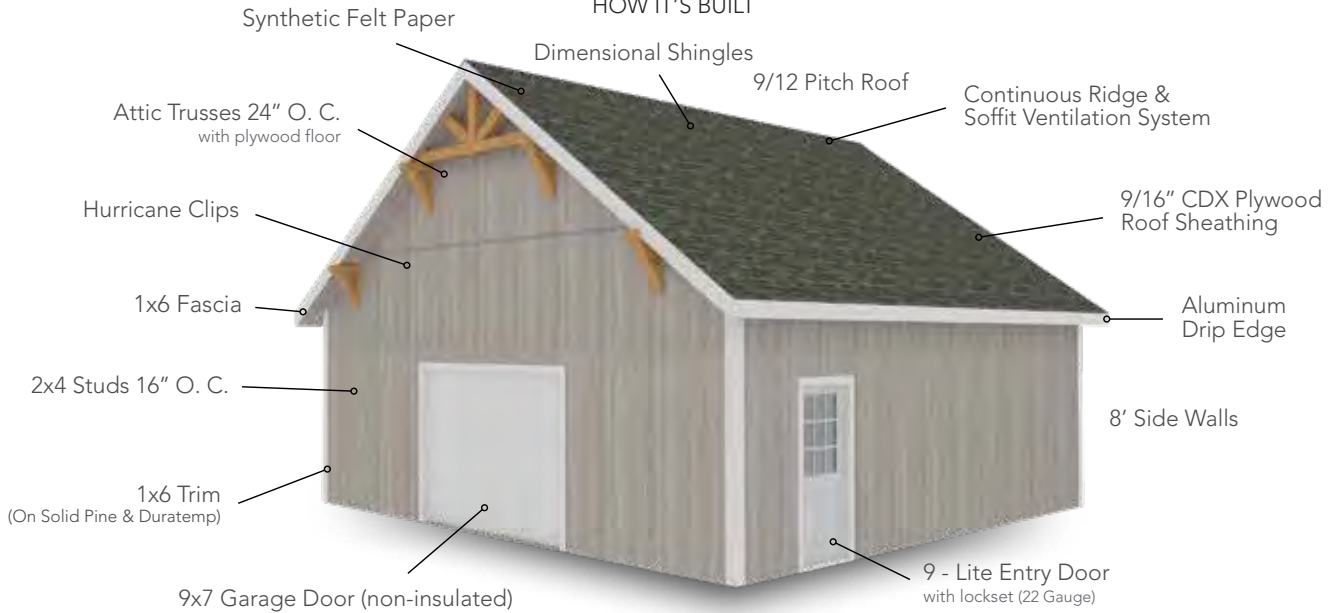

INFORMATION

*free delivery for 30 miles, delivery charges may apply beyond 30 Miles

The Heritage is real property No additional sales tax charged

Floor is not included

BUILDING HEIGHTS

20' Wide = 16' 2" High
 24' Wide = 17' 8" High
 30' Wide = 19' 11" High



SIDING CHOICES [View Pricing Guide For Current Pricing](#)

SMARTSIDE LAP SIDING

- 50 YEAR LIMITED WARRANTY
- Natural Wood Grain Texture
- 100% Clear
- Pre-Primed
- 50 Year Limited Warranty



VINYL SIDING

- Maintenance Free
- .044 Thickness
- Match Your Home
- CDX Plywood Subsidizing



PINE SIDING

- 1 x 8 Premium Grade Pine Siding
- Exclusive Rough Sawn Finish
- Aesthetically Pleasing
- Tongue & Groove



BOARD & BATTEN

- 50 YEAR LIMITED WARRANTY
- Natural Wood Grain Texture
- 100% Clear
- Pre-Primed
- 50 Year Limited Warranty



DURATEMP SIDING

- 50 YEAR LIMITED WARRANTY
- Natural Wood Grain Texture
- 100% Clear
- Pre-Primed
- 50 Year Limited Warranty



SMARTSIDE SIDING

- 50 YEAR LIMITED WARRANTY
- Natural Wood Grain Texture
- 100% Clear
- Pre-Primed
- 50 Year Limited Warranty



Rockport

OPTIONS ON THIS 32x24

- Vinyl Windows
- 3' x 4' Vinyl Windows
- Stone Work
- Cupola
- Onyx Black Dimensional Shingles
- Board & Batten Vinyl Siding
- 16' x 7' Carriage House Door
- Windows In Garage Door 2' x 3'



ROCKPORT ESTIMATE MATRIX



Two Car Basic

- Size: 24 x 20
- Painted Smartside Siding
- 1 - 16 x 7 Insulated Garage Doors
- 1 - 9 Light Steel Door
- Loft with Attic Ladder
- 30 Year Shingle Roof
- 8' Walls

Estimated Price **\$36,300**
 + Foundation & Concrete \$9,000 - \$13,000



Two Car Deluxe

- Size: 32 x 24
- Vinyl Siding
- 1 - 16 x 7 Insulated Carriage Doors
- 4 - 2 x 3 Vinyl Window
- 1 - 9 Light Steel Door
- 30 Year Shingle Roof
- Loft with Attic Ladder
- 8' Walls
- 42" Stone Wainscot (2 Sides)

Estimated Price **\$56,100**
 + Foundation & Concrete \$12,000 - \$16,000



Three Car Deluxe

- Size: 40 x 30
- Vinyl Siding
- 1 - 16 x 8
- 1 - 10 x 8
- 4 - 2 x 4 Vinyl SH
- Dimensional Shingles
- 3/4 Glass Entry
- 32" Stone Wainscot (2 Sides)
- 10' Walls
- Attic Truss w/ Loft & Ladder
- Cupola

Estimated Price **\$87,500**
 + Foundation & Concrete \$15,000 - \$21,000



BASE PRICE UNIT

HOW IT'S BUILT

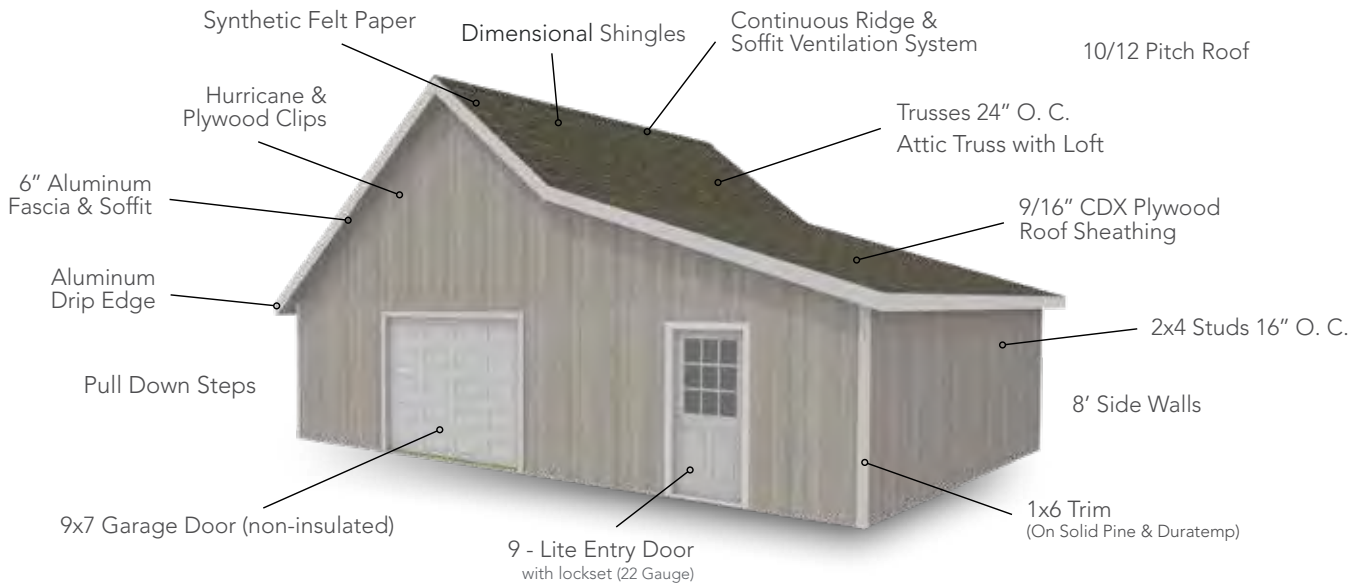

INFORMATION

*free delivery for 30 miles, delivery charges may apply beyond 30 Miles

The Rockport is real property No additional sales tax charged

Floor is not included

BUILDING HEIGHTS

20' Wide = 17' 1" High
 24' Wide = 18' 9" High
 30' Wide = 21' 3" High



SIDING CHOICES View Pricing Guide For Current Pricing

SMARTSIDE LAP SIDING

- 50 YEAR LIMITED WARRANTY
- Natural Wood Grain Texture
- 100% Clear
- Pre-Primed
- 50 Year Limited Warranty



VINYL SIDING

- Maintenance Free
- .044 Thickness
- Match Your Home
- CDX Plywood Subsidizing



PINE SIDING

- 1 x 8 Premium Grade Pine Siding
- Exclusive Rough Sawn Finish
- Aesthetically Pleasing
- Tongue & Groove



BOARD & BATTEN

- 50 YEAR LIMITED WARRANTY
- Natural Wood Grain Texture
- 100% Clear
- Pre-Primed
- 50 Year Limited Warranty



DURATEMP SIDING

- 50 YEAR LIMITED WARRANTY
- Natural Wood Grain Texture
- 100% Clear
- Pre-Primed
- 50 Year Limited Warranty



SMARTSIDE SIDING

- 50 YEAR LIMITED WARRANTY
- Natural Wood Grain Texture
- 100% Clear
- Pre-Primed
- 50 Year Limited Warranty



Willow Creek

OPTIONS ON THIS 24x36

- 9x7 Long Panel Carriage House Doors
- Timbers Stained Pioneer
- Textured Legacy Metal Roof
- Painted Steel Entry Door
- White Vinyl Board & Batten Siding
- Door Awning
- 8' Lean-to with RS Pine Timbers
- Black Vinyl Window Package
- 40" Traditional Cupola with Black Roof
- Copper Eagle Weathervane



WILLOW CREEK ESTIMATE MATRIX



Two Car Basic

Size: 20 x 24
 Painted Smartside Siding
 1 - 16 x 7 Insulated Garage Doors
 1 - 9 Light Steel Door
 Shingle Roof
 10' Walls
 Half Loft & Steps with Landing

Estimated Price \$42,300
 + Foundation & Concrete \$9,000 - \$13,000



Two Car Deluxe

Size: 24 x 32
 Painted Smartside Siding
 2 - 9 x 7 Insulated Carriage Doors
 4 - 2 x 4 + 3 - 2 x 3 Aluminum Windows
 1 - 9 Light Steel Door
 Dimensional Shingle Roof
 10' Walls
 Half Loft & Steps with Landing
 Awning

Estimated Price \$60,900
 + Foundation & Concrete \$12,000 - \$16,000



Three Car Deluxe

Size: 24 x 36
 Stained Pine Siding
 2 - 9 x 7 Insulated Carriage Doors
 5 - 2 x 4 + 3 - 2 x 3 Aluminum Windows
 1 - 9 Light Steel Door
 40 Year Metal Roofing + Cupola
 10' Walls + 8' Lean-to
 Half Loft & Steps with Landing
 Awning

Estimated Price \$87,200
 + Foundation & Concrete \$14,000 - \$19,000



BASE PRICE UNIT

HOW IT'S BUILT

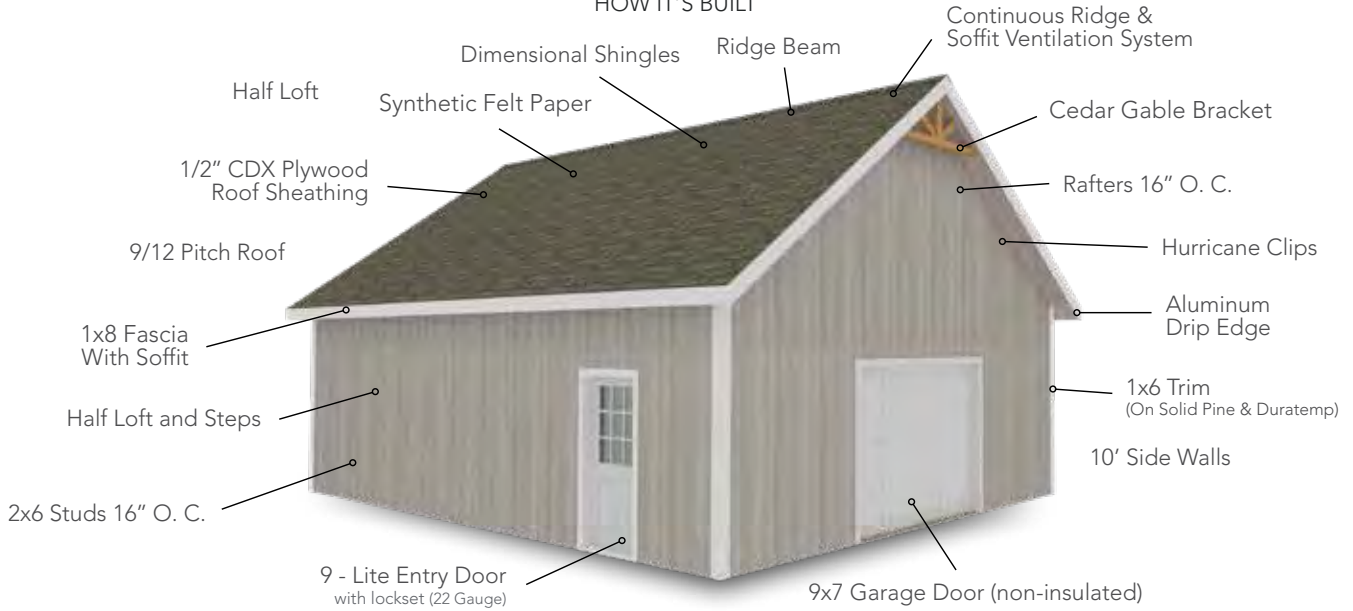

INFORMATION

*free delivery for 30 miles, delivery charges may apply beyond 30 Miles

The Willow Creek is real property No additional sales tax charged

Floor is not included

BUILDING HEIGHTS

20' Wide = 18' 2" High
 24' Wide = 19' 8" High
 30' Wide = 21' 11" High



SIDING CHOICES View Pricing Guide For Current Pricing

SMARTSIDE LAP SIDING

- 50 YEAR LIMITED WARRANTY**
- Natural Wood Grain Texture
 - 100% Clear
 - Pre-Primed
 - 50 Year Limited Warranty



VINYL SIDING

- Maintenance Free
- .044 Thickness
- Match Your Home
- CDX Plywood Subsidizing



PINE SIDING

- 1 x 8 Premium Grade Pine Siding
- Exclusive Rough Sawn Finish
- Aesthetically Pleasing
- Tongue & Groove



BOARD & BATTEN

- 50 YEAR LIMITED WARRANTY**
- Natural Wood Grain Texture
 - 100% Clear
 - Pre-Primed
 - 50 Year Limited Warranty



DURATEMP SIDING

- 50 YEAR LIMITED WARRANTY**
- Natural Wood Grain Texture
 - 100% Clear
 - Pre-Primed
 - 50 Year Limited Warranty



SMARTSIDE SIDING

- 50 YEAR LIMITED WARRANTY**
- Natural Wood Grain Texture
 - 100% Clear
 - Pre-Primed
 - 50 Year Limited Warranty



Cascade

OPTIONS ON THIS 24x32

- Black Metal Roofing
- Custom Window Package
- 32' Awning
- 10x8 #360 Full Glass Garage Doors
- Painted Full Glass Entry Door
- SW Iron Ore / Black / Pecan



CASCADE ESTIMATE MATRIX



Two Car Basic

- Size: 20 x 24
- Painted LP Lap Siding
- Metal Roof
- 1 - 16x8 5000 Series Garage Door
- 1 - Full Glass Entry Door

Estimated Price **\$46,800**
 + Foundation & Concrete \$9,000 - \$13,000



Two Car Deluxe

- Size: 24x32
- Painted LP Siding (*Lap and Board & Batten*)
- 2 - 18x60 Black Vinyl Window
- 2 - 18x40 Black Vinyl Window
- 2 - 18x28 Black Vinyl Window
- 2 - 10x8 #360 Full Glass Garage Doors
- Full Glass Entry Door
- Legacy Panel Metal Roof
- 32' Timber Awning

Estimated Price **\$78,100**
 + Foundation & Concrete \$12,000 - \$16,000



Three Car Deluxe

- Size: 24x40
- Painted LP Siding (*Lap and Board & Batten*)
- 3 - 20x108 Black Vinyl Window
- 1 - 36x50 Black Vinyl Window
- 3 - 10x8 #360 Full Glass Garage Doors
- Stained Fiberglass Entry Door
- Legacy Panel Metal Roof
- 40' Timber Awning

Estimated Price **\$95,300**
 + Foundation & Concrete \$18,000 - \$21,000



BASE PRICE UNIT

HOW IT'S BUILT

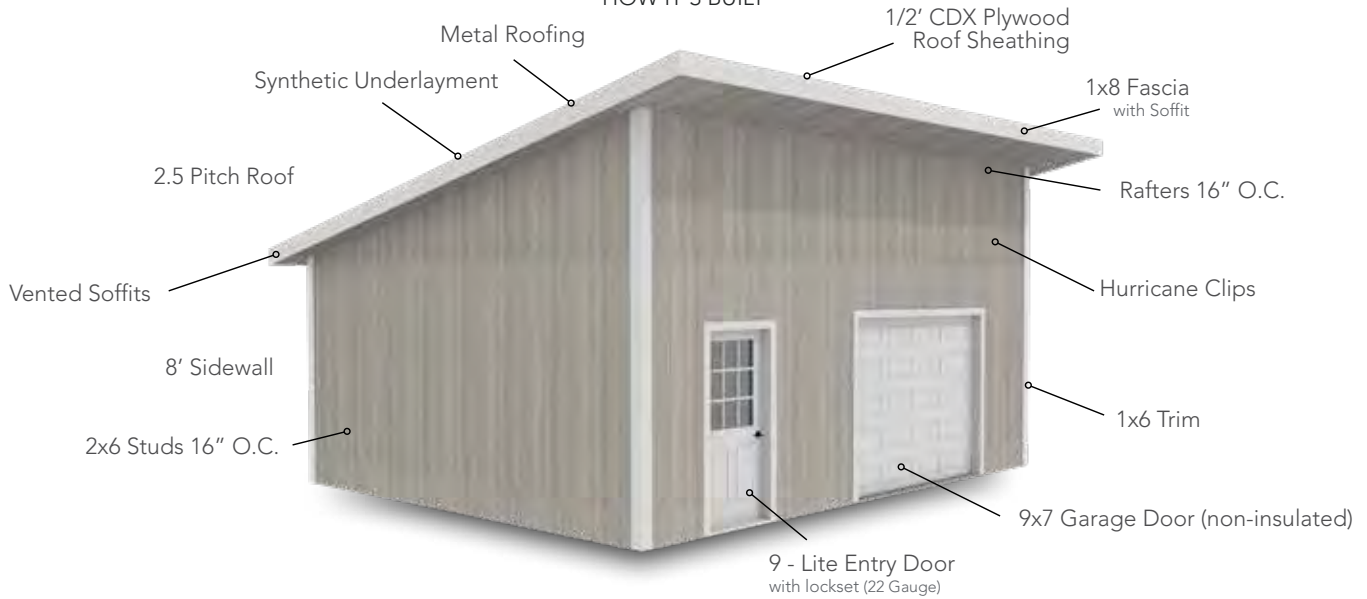

INFORMATION

*free delivery for 30 miles, delivery charges may apply beyond 30 Miles

The Cascade is real property No additional sales tax charged

Floor is not included

BUILDING HEIGHTS

20' Wide = 14' 1" High
 24' Wide = 14' 11" High
 28' Wide = 15' 9" High



SIDING CHOICES [View Pricing Guide For Current Pricing](#)

SMARTSIDE LAP SIDING

- 50 YEAR LIMITED WARRANTY
- Natural Wood Grain Texture
- 100% Clear
- Pre-Primed
- 50 Year Limited Warranty



VINYL SIDING

- Maintenance Free
- .044 Thickness
- Match Your Home
- CDX Plywood Subsidizing



PINE SIDING

- 1 x 8 Premium Grade Pine Siding
- Exclusive Rough Sawn Finish
- Aesthetically Pleasing
- Tongue & Groove



BOARD & BATTEN

- 50 YEAR LIMITED WARRANTY
- Natural Wood Grain Texture
- 100% Clear
- Pre-Primed
- 50 Year Limited Warranty



DURATEMP SIDING

- 50 YEAR LIMITED WARRANTY
- Natural Wood Grain Texture
- 100% Clear
- Pre-Primed
- 50 Year Limited Warranty



SMARTSIDE SIDING

- 50 YEAR LIMITED WARRANTY
- Natural Wood Grain Texture
- 100% Clear
- Pre-Primed
- 50 Year Limited Warranty



Dutch Garage

OPTIONS ON THIS 24x32

- Legacy Black Metal Roof
- 3' x 4' SH Vinyl Window
- 2' x 3' SH Vinyl Window
- Shutter Sets
- Cedar Vent
- 20' Open Rafter Awning
- 16' x 8' Garage Door
- 10' x 8' Sliding Barn Doors
- 6' French Doors, Painted
- 9' Sidewall
- White/Pecan



DUTCH GARAGE ESTIMATE MATRIX



Two Car Basic

- Size: 24 x 24
 Painted Smartside Siding
 1 - 16 x 8 Non-Insulated Garage Door
 1 - 9 Light Steel Door
 1 - 3 x 4 Vinyl Window
 1 - 2 x 3 Vinyl Window
 Cedar Shutters
 9' Sidewall
 Attic Truss + Loft + Pull Down Steps
 Dimensional Shingles

Estimated Price **\$41,200**
 + Foundation & Concrete \$9,000 - \$14,000



Two Car Deluxe

- Size: 24 x 28
 Painted Duratemp Siding
 2 - 9 x 8 Carriage House Doors
 1 - 72" Full Glass Steel Doors
 1 - 10 x 8 Cedar Sliding Barn Doors
 Open Rafter Awning
 1 - 2 x 4 Vinyl Window
 Shutter Set
 9' Sidewalls
 3' Stone Wainscot (2 sides)
 Legacy Panel Metal Roof
 Attic Truss + Loft + Pull Down Steps

Estimated Price **\$59,900**
 + Foundation & Concrete \$12,000 - \$16,000



Three Car Deluxe

- Size: 24 x 36
 Painted Board & Batten Siding
 2 - 9 x 8 Carriage House Doors
 1 - 72" Full Glass Steel Doors
 1 - 10 x 8 Cedar Sliding Barn Doors
 Open Rafter Awning
 1 - 3 x 4, 2 x 4 Window
 Shutter Sets
 9' Sidewalls
 3' Stone Wainscot (2 Sides)
 Legacy Panel Metal Roof
 Attic Truss With Steps and Landing + Railing

Estimated Price **\$77,500**
 + Foundation & Concrete \$13,000 - \$19,000

Dutch Garage



BASE PRICE UNIT

HOW IT'S BUILT

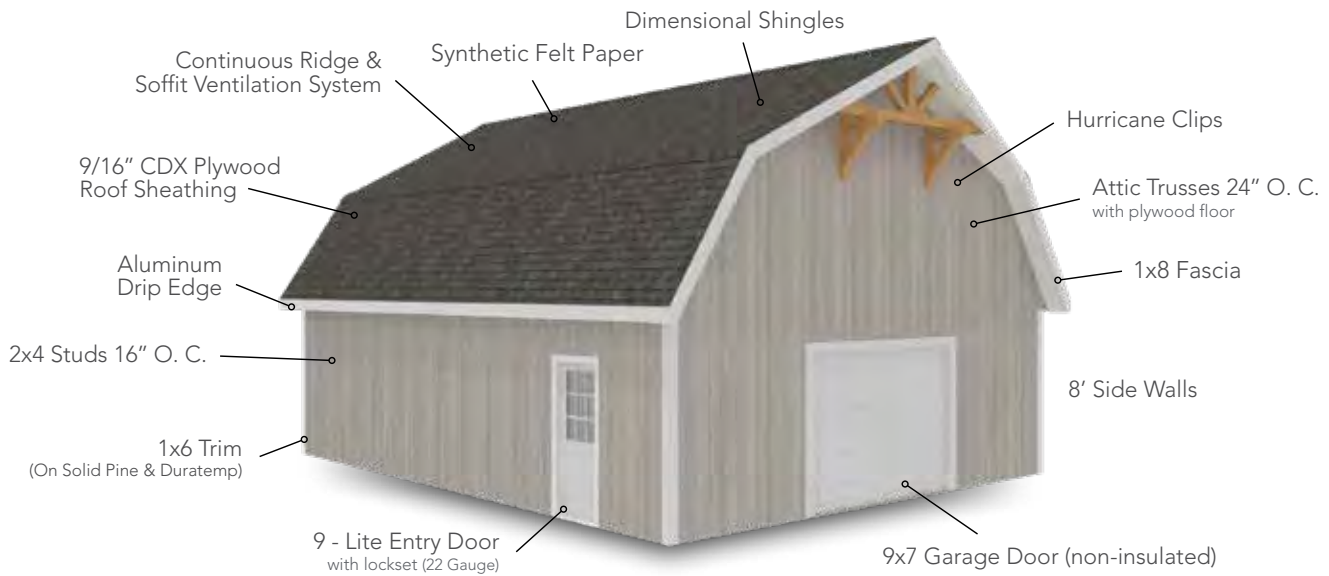

INFORMATION

*free delivery for 30 miles, delivery charges may apply beyond 30 Miles

The Dutch is real property No additional sales tax charged

Floor is not included

BUILDING HEIGHTS
 20' Wide = 17' 8" High
 24' Wide = 19' 8" High



SIDING CHOICES [View Pricing Guide For Current Pricing](#)

<p>SMARTSIDE LAP SIDING</p> <p>50 YEAR LIMITED WARRANTY</p> <ul style="list-style-type: none"> Natural Wood Grain Texture 100% Clear Pre-Primed 50 Year Limited Warranty 	<p>VINYL SIDING</p> <ul style="list-style-type: none"> Maintenance Free .044 Thickness Match Your Home CDX Plywood Subsidizing 	<p>PINE SIDING</p> <ul style="list-style-type: none"> 1 x 8 Premium Grade Pine Siding Exclusive Rough Sawn Finish Aesthetically Pleasing Tongue & Groove 	<p>BOARD & BATTEN</p> <p>50 YEAR LIMITED WARRANTY</p> <ul style="list-style-type: none"> Natural Wood Grain Texture 100% Clear Pre-Primed 50 Year Limited Warranty 	<p>DURATEMP SIDING</p> <p>50 YEAR LIMITED WARRANTY</p> <ul style="list-style-type: none"> Natural Wood Grain Texture 100% Clear Pre-Primed 50 Year Limited Warranty 	<p>SMARTSIDE SIDING</p> <p>50 YEAR LIMITED WARRANTY</p> <ul style="list-style-type: none"> Natural Wood Grain Texture 100% Clear Pre-Primed 50 Year Limited Warranty
---	---	---	---	--	---

Dutch Barn

OPTIONS ON THIS 24x32

10' x 7' Double Sliding Door w/ Transoms
 Loft door w/ Transom
 Onyx Black Dimensional Shingles
 Painted Steel Entry Door

Custom Cupola
 Mountain Red / White
 2' x 3' Windows
 6' Lean to



DUTCH BARN ESTIMATE MATRIX



Basic Barn

Size: 20 x 24
 Painted Smartside Siding
 1 - 16 x 7 Insulated Garage Doors
 1 - 9 Light Steel Door
 Painted Door
 Dimensional Shingle Roof
 9' Walls
 Half Loft With Steps & Landing

Estimated Price **\$36,900**
 + Foundation & Concrete \$9,000 - \$13,000



Deluxe Barn

Size: 24 x 32
 Painted Smartside Siding
 2 - 9 x 7 Insulated Carriage Doors
 3 - 3 x 4 Vinyl Window
 1 - 9 Light Steel Door
 Dimensional Shingle Roof
 9' Walls
 Half Loft & Steps with Landing
 8' Lean-to

Estimated Price **\$62,800**
 + Foundation & Concrete \$12,000 - \$16,000



Ultimate Barn

Size: 24 x 36
 Painted Duratemp Siding
 2 - 9 x 7 Insulated Carriage Doors
 8 - 3 x 4 Vinyl Window
 1 - 9 Light Steel Door + Loft Door
 40 Year Metal Roof + Cupola
 9' Walls
 Half Loft & Steps with Landing
 8' Lean-to

Estimated Price **\$77,800**
 + Foundation & Concrete \$14,000 - \$19,000

Dutch Barn

Garages



BASE PRICE UNIT

HOW IT'S BUILT



INFORMATION

**free delivery for 30 miles, delivery charges may apply beyond 30 Miles*

The Dutch is real property No additional sales tax charged

Floor is not included

BUILDING HEIGHTS

20' Wide = 16' 2" High
24' Wide = 17' 8" High
30' Wide = 19' 11" High



SIDING CHOICES [View Pricing Guide For Current Pricing](#)

SMARTSIDE LAP SIDING

- 50 YEAR LIMITED WARRANTY
- Natural Wood Grain Texture
- 100% Clear
- Pre-Primed
- 50 Year Limited Warranty



VINYL SIDING

- Maintenance Free
- .044 Thickness
- Match Your Home
- CDX Plywood Subsidizing



PINE SIDING

- 1 x 8 Premium Grade Pine Siding
- Exclusive Rough Sawn Finish
- Aesthetically Pleasing
- Tongue & Groove



BOARD & BATTEN

- 50 YEAR LIMITED WARRANTY
- Natural Wood Grain Texture
- 100% Clear
- Pre-Primed
- 50 Year Limited Warranty



DURATEMP SIDING

- 50 YEAR LIMITED WARRANTY
- Natural Wood Grain Texture
- 100% Clear
- Pre-Primed
- 50 Year Limited Warranty



SMARTSIDE SIDING

- 50 YEAR LIMITED WARRANTY
- Natural Wood Grain Texture
- 100% Clear
- Pre-Primed
- 50 Year Limited Warranty





Frontier CABIN

OPTIONS

Smoke / Black / Deep Ruby
 6' Timber Porch
 10' Sidewalls
 Clay Window Package

ON THIS 16x24 | 576 Sq Ft.
 9-Lite & 15-Lite Steel Doors, Painted
 14' Shed Dormers, Front & Back
 2x4 Interior Wall Framing
 Galvalume Metal Roofing

BASE PRICE UNIT

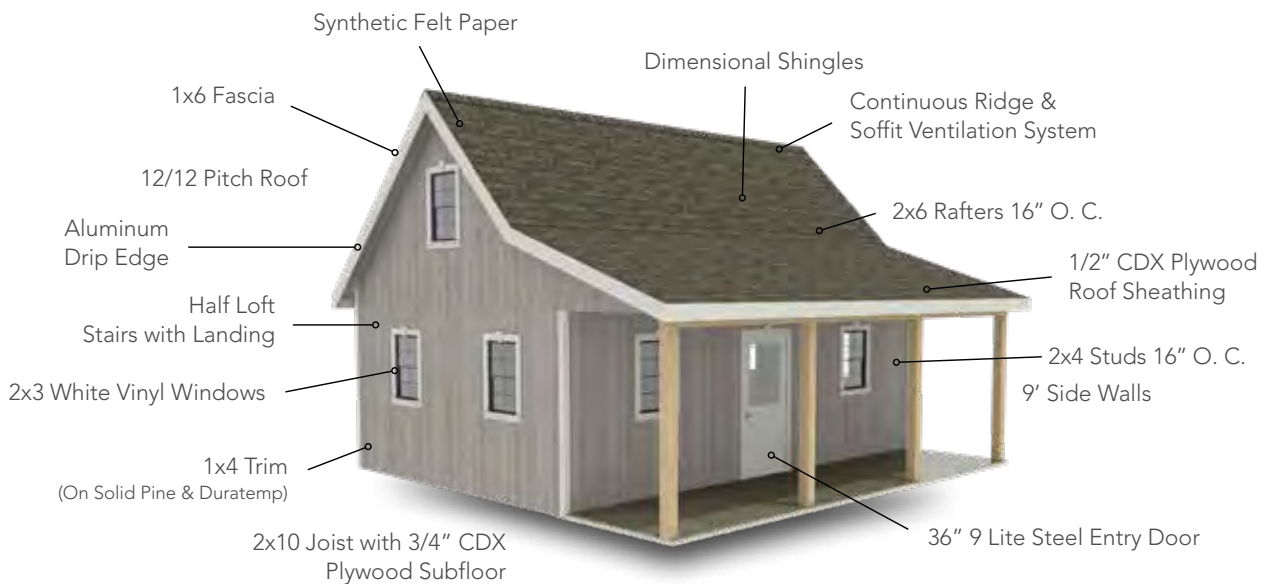



Aspen CABIN

OPTIONS
 ON THIS 20x26 | 520 Sq Ft.
 Black Window Package
 Interior Wall Framing

BASE PRICE UNIT



Floorplan

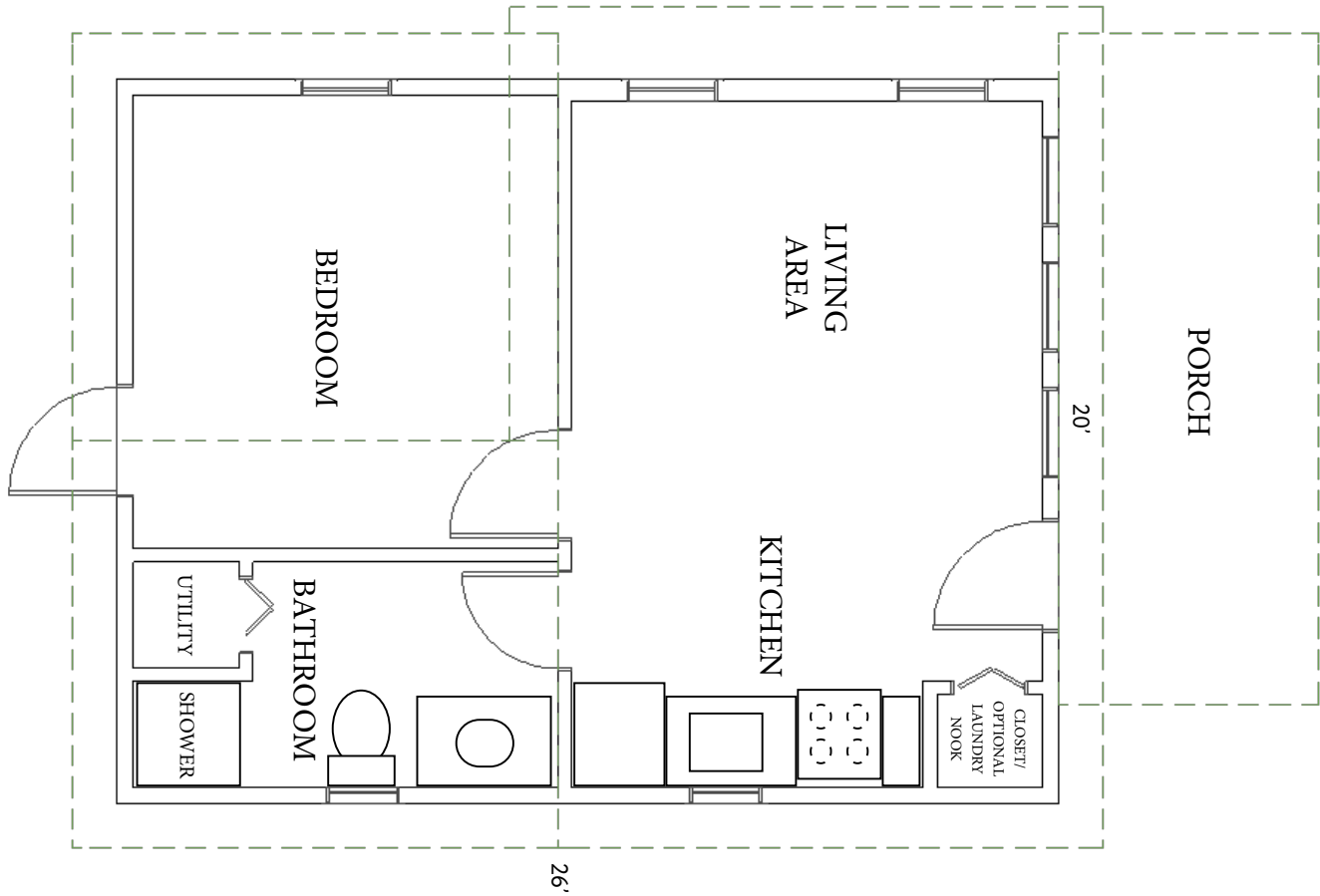



Custom Homes & SPECIAL PROJECTS

At Weaver Barns we pride ourselves in our ability to build many different types of projects. Our clients come to us with a wide variety of unique requests and with our highly skilled team of craftsman we turn these dreams into reality. Talk to us about your custom dream project.



Rocky Ridge | Homes

Size 20 x 32 960 Sq. Ft.



MAIN FLOOR

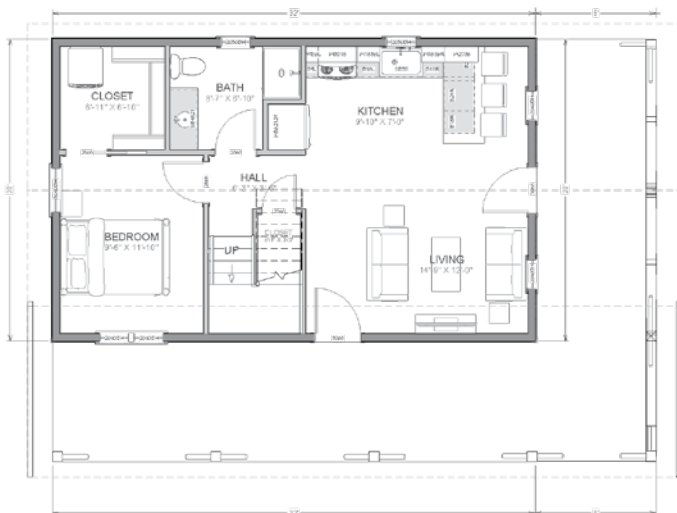

SECOND FLOOR

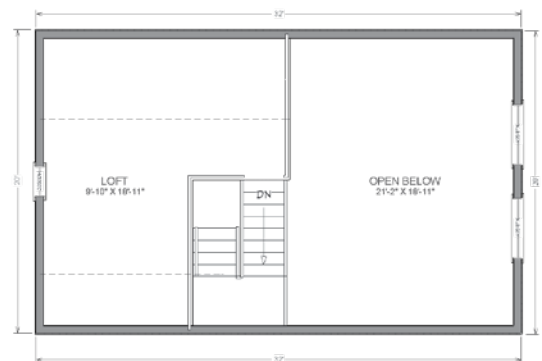

Cedar Brooke

Homes

Size 26 x 36 1404 Sq. Ft.



MAIN FLOOR

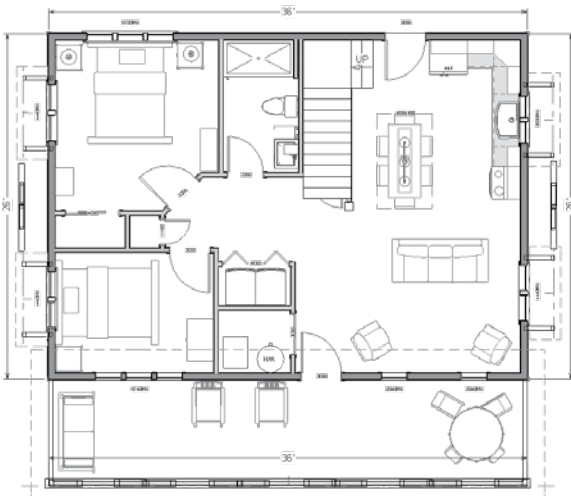

SECOND FLOOR



Cedar Brooke

Homes

Size 26 x 36 1512 Sq. Ft.

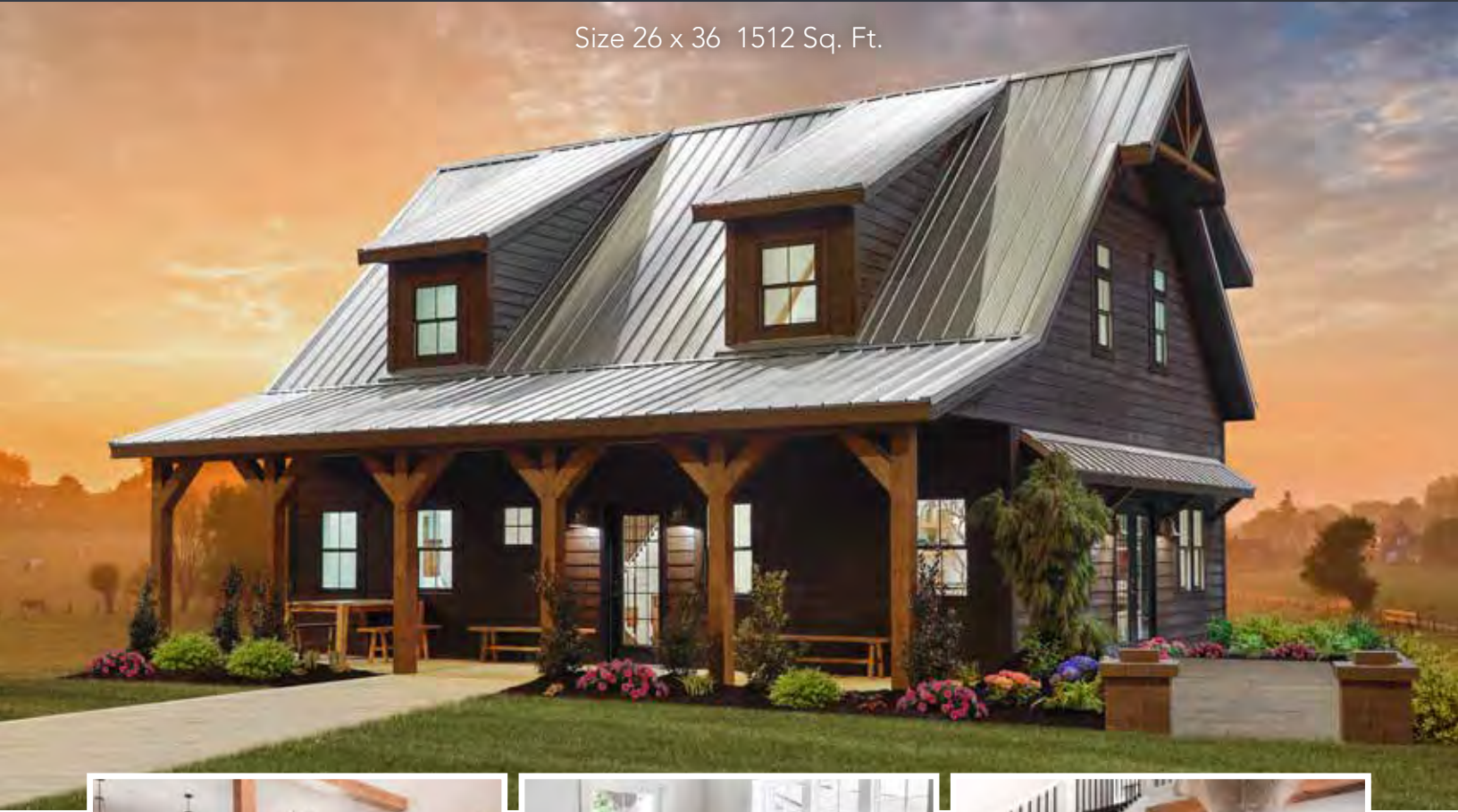

MAIN FLOOR



SECOND FLOOR



visit us online at www.weaverbarns.com

Timber Lodge

Homes

Size 24 x 36 1296 Sq. Ft.



MAIN FLOOR

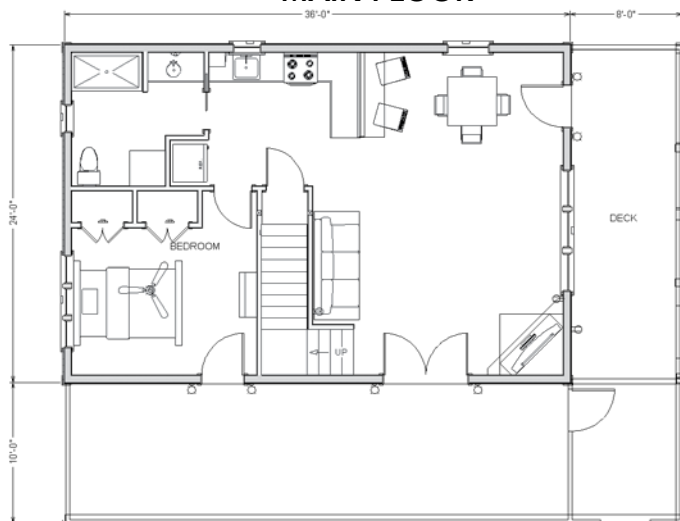

SECOND FLOOR

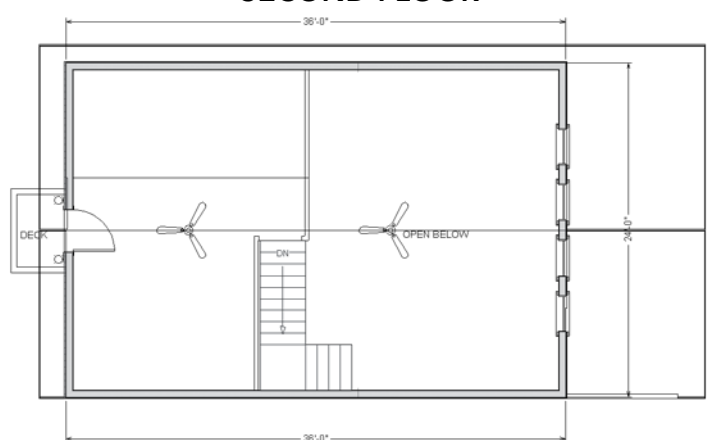

Grand Lake | Homes

Size 32 x 40 2161 Sq. Ft.

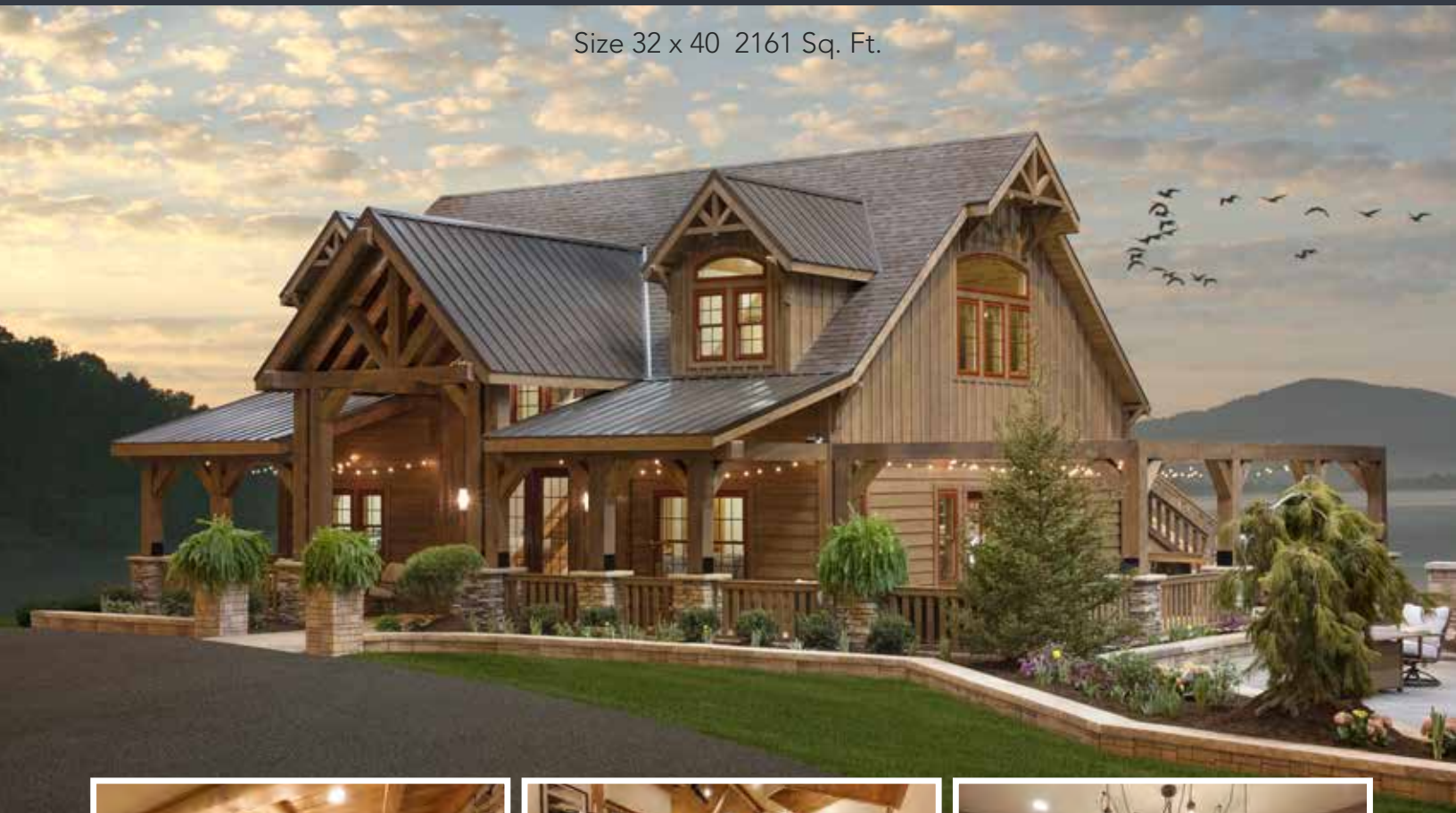

MAIN FLOOR

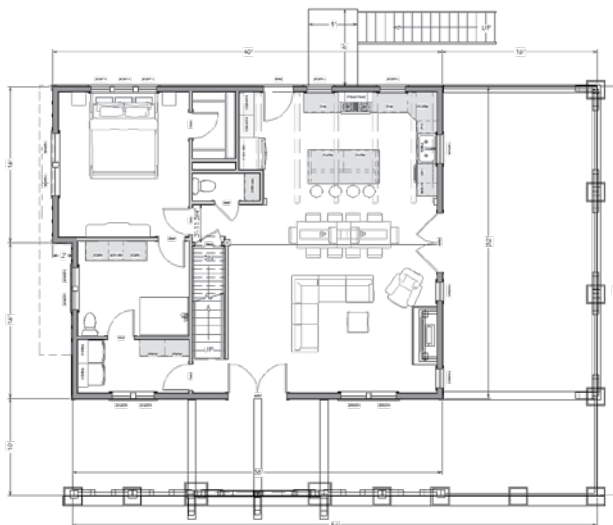

SECOND FLOOR

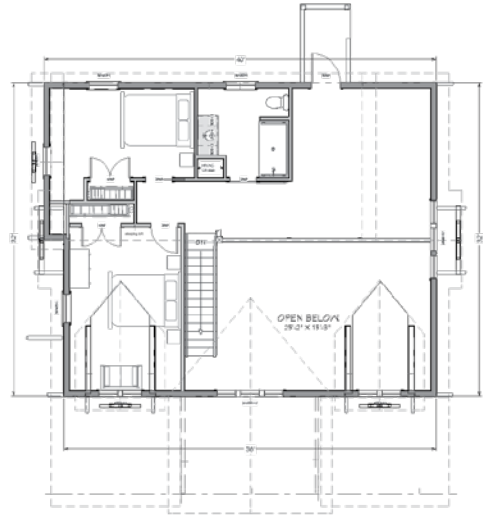

DOORS

NOTE: Due to the effect of light, age and printing process, all color samples on these pages may vary in color or sheen from the actual materials.

WOOD DOUBLE DOORS



#100
SIZES - 4' 5'
6' 7'



#102-TW
SIZES - 4' 5'
6' 7'



#101-SW
SIZES - 5' 6'



#103-AW
SIZES - 5' 6'



#200
SIZES - 4' 5'
6' 7'



#202-TW
SIZES - 4' 5'
6' 7'



#203-LW
SIZES - 5' 6'



#204-FW
SIZES - 5' 6'

WOOD SINGLE DOORS



#100-SD
SIZES - 30" 36"



#102-SD
SIZES - 30" 36"



#101-SD
SIZES - 30" 36"



#103-SD
SIZES - 36"



#200-SD
SIZES - 30" 36"



#202-SD
SIZES - 30" 36"



#203-SD
SIZES - 30" 36"

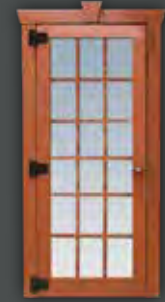

#204-SD
SIZES - 36"

WOOD TRIPLE DOORS



#100-TD
SIZES 7'6" - 9'

WOOD SLIDING DOORS



10'x7'



10'x7' with Transoms

VINYL DOORS



#200V
SIZES - 4' 5' 6' 7'



#200-SDV
SIZES - 30" 36"



#202-SDV
SIZES - 30" 36"

Optional Colors



Sandalwood

Gray

Pewter

Clay

STEEL ENTRY DOORS

Dead Bolt +\$ Painted Steel Door + \$ Stock Grid Colors White - Black - Clay - Bronze Special Grid Colors +\$



36" 6-Panel
ECO (no-paint)
24 Gauge
22 Gauge



36" 9-Lite
ECO (no-paint)
24 Gauge
22 Gauge



36" 15-Lite
22 Gauge



36" 3-Lite
22 Gauge



72" 6-Panel
22 Gauge

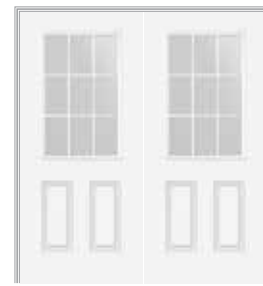

72" 9-Lite
22 Gauge

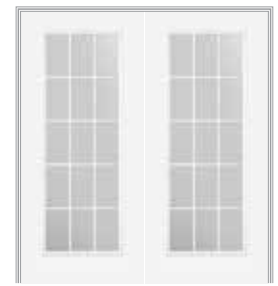

72" 15-Lite
22 Gauge

Steel Door Colors *Paint Is An Additional Charge



OVERHEAD GARAGE DOORS

Garage Door Opener w/ One Remote +\$ Additional Remote +\$



Standard Door
Available non-insulated or insulated

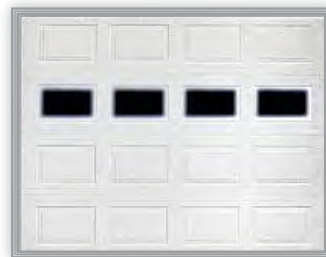

Standard Door with Optional Windows
Available non-insulated or insulated



Carriage House Door
Insulated



Glass Garage Door

Garage Door Colors

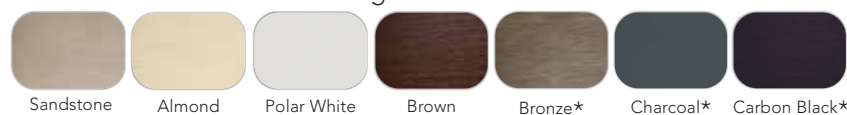

Sandstone

Almond

Polar White

Brown

Bronze*

Charcoal*

Carbon Black*

*Only available on Standard Insulated and Carriage House Doors

DOOR RAMPS



Door Ramps

3' depth X width of door
 4' depth X width of door
 5' depth X width of door
 Ramps in Excess of 5' (per sq. ft.)



Diamond Plate Thresholds

DECORATIVES



Cedar Gable Vents



Peak Extension

RAILING



1 x 4 Pine & Cedar Railing
 *Available In Vinyl



2 x 2 Pine & Treated Railing
 *Available In Vinyl

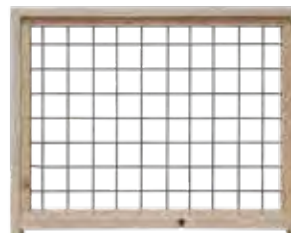

Wire Panel Railing
 *Interior Only



Rebar Railing
 *Interior Only

STAIRS & LADDERS



Attic Ladder



Straight Steps
 (1x4 Railing Upgrade Shown)
 Add Risers Plates



Steps With Landing & Handrail
 (Standard 2x2 Railing Shown)
 Add Risers Plates



Exterior Treated Steps
 3 treads
 Steps & Landing, Cedar Railing
 Additional Tread
 Exterior treated landing



**Sliding
 Stair Ladder**

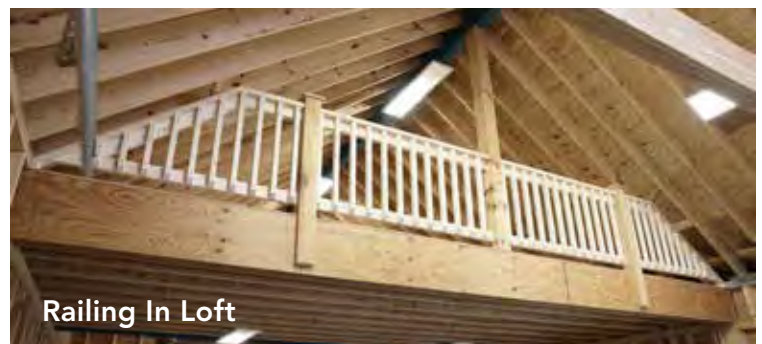

Railing In Loft

WINDOWS

ALUMINUM SINGLE HUNG WINDOWS

Includes Screens & Grids - Choose: White/Brown/Black



AVAILABLE COLORS

VINYL WINDOWS

Includes Screens & Grids - Color: White Upgrade: Almond, Black, Clay Muller Window

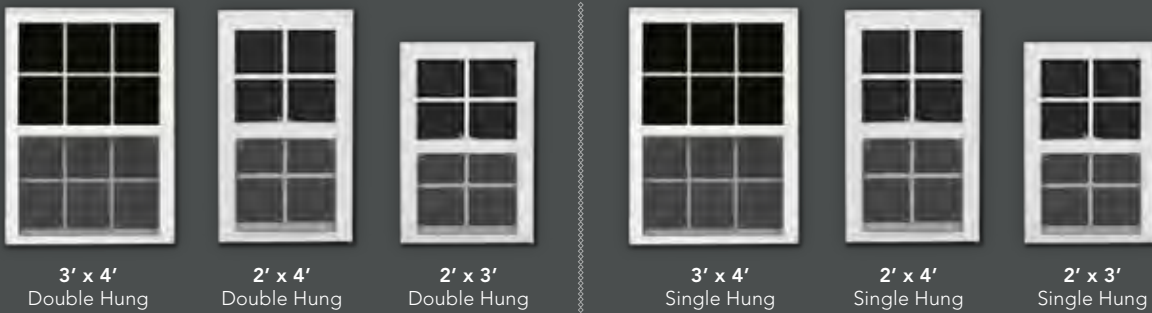

AVAILABLE COLORS

ACCENT WINDOWS & SKYLIGHTS



Octagon
White/Brown



Aluminum Transom
White/Brown



Vinyl Transom
White

2'x4' SKYLIGHT
Insulated

WOOD PANEL STYLE SHUTTERS



K Panel Shutter



Plain Panel Shutter

WOOD/VINYL SHUTTERS & FLOWER BOXES

WOOD



Wood Shutters & Flower Box

Wood Shutters

**Wood Shutters
Z Strap**

Wood Flower Box

VINYL



Vinyl Shutters & Flower Box

Vinyl Shutters

Vinyl Flower Box

CUPOLAS & WEATHERVANES



24"

32"

40"

Traditional Cupola

SOLID CEDAR + BRONZE METAL ROOF Standard



24"

32"

40"

Windowpane Cupola

SOLID CEDAR + BRONZE METAL ROOF Standard
*Frosted Plexi-Glass Standard, Clear Available

LARGE WEATHERVANE

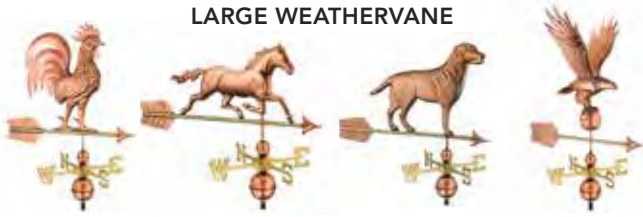

Rooster

Horse

Dog

Eagle

SMALL WEATHERVANE



Rooster

Horse

Dog

Eagle

ROOFING COLORS



Galvalume



Bronze



Black

CUPOLA OPTIONS

Colored Metal Roof

110V Light inside Cupola

SHELVES & WORKBENCHES

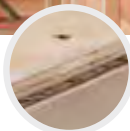

Beveled

1' DEPTH

8' x 1' (2 x 4 Joists)

10' x 1' (2 x 4 Joists)

12' x 1' (2 x 4 Joists with Center Post)

14' x 1' (2 x 4 Joists with Center Post)

16' x 1' (2 x 4 Joists with Center Post)

2' DEPTH

8' x 2' (2 x 4 Joists)

10' x 2' (2 x 4 Joists)

12' x 2' (2 x 4 Joists with Center Post)

14' x 2' (2 x 4 Joists with Center Post)

16' x 2' (2 x 4 Joists with Center Post)



Beveled

WORKBENCH (FREESTANDING)

8' x 2'

10' x 2'

12' x 2'

STANDARD LOFTS & CUSTOM LOFTS

STANDARD SIZES

8' x 4' (2 x 4 Joists 16" O.C.)

10' x 4' (2 x 4 Joists 16" O.C.)

12' x 4' (2 x 6 Joists 16" O.C.)

14' x 4' (2 x 8 Joists 16" O.C.)

16' x 4' (2 x 8 Joists 16" O.C.)

CUSTOM SIZES

2 x 8 with 5/8" plywood (per sq. ft.)

2 x 10 with 3/4" plywood (per sq. ft.)

I-joists with 3/4" plywood (per sq. ft.)



AWNINGS & ARBORS

*Min. 7/12 Pitch Required



Shed Awnings

Door Awning for Man Door (56")
(open ceiling)
Door Awning for Garage Door (22')
(flat ceiling)



Door Arbors

Door Arbor for 4' Door
Door Arbor for 5' Door
Door Arbor for 6' Door



Easton Awning

Door Arbor for 4' Door
Door Arbor for 5' Door
Door Arbor for 6' Door



Open Rafter Awning



Closed Rafter Awning

ROOF PITCH

Sheds Steeper Roof Pitch (up to 8/12 Pitch)

(per sq. ft. X 1 pitch increase)

Sheds Steeper Roof Pitch (9/12 to 12/12 Pitch)

(per sq. ft. X 1 pitch increase)

Large Structures Steeper Roof Pitch (up to 7/12 Pitch)

(per sq. ft. X 1 pitch increase)

**Ask Your Sales Representative for 8/12 & Higher Pitch Prices*



SIDEWALLS

SHEDS & BARNs

1' increments per perimeter foot

Duratemp Buildings

Pine Buildings

Vinyl Buildings

PAVILIONS

Per Post Per Foot Up To 10'

CABINS, GARAGES & HOMES

1' increments per perimeter foot

Duratemp Buildings

Pine Buildings

Vinyl Buildings

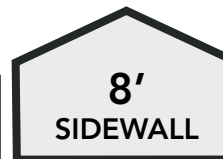

TRIM STYLES



CRAFTSMAN
*STANDARD STYLE



SQUARE CUT

GABLE BRACKETS



Timber Frame Bracket

SHINGLES

15# Felt Paper (per sq. ft.) +\$

STANDARD DIMENSIONAL



OPTIONAL DURATION



OPTIONAL METAL ROOF



NOTE: Due to the effect of light, age and printing process, all color samples on these pages will vary in color or sheen from the actual materials.

METAL ROOF (per sq. ft.)
 Manchester & Craftsman (per sq. ft.)
 Large Structures (per sq. ft.)
 Dutch & Cumberland (per sq. ft.)
 Legacy Panel Upgrade (per sq. ft.)
 Textured Panel Upgrade (per sq. ft.)

VINYL SIDING COLORS

STANDARD COLORS



PREMIUM COLORS



PAINT COLORS

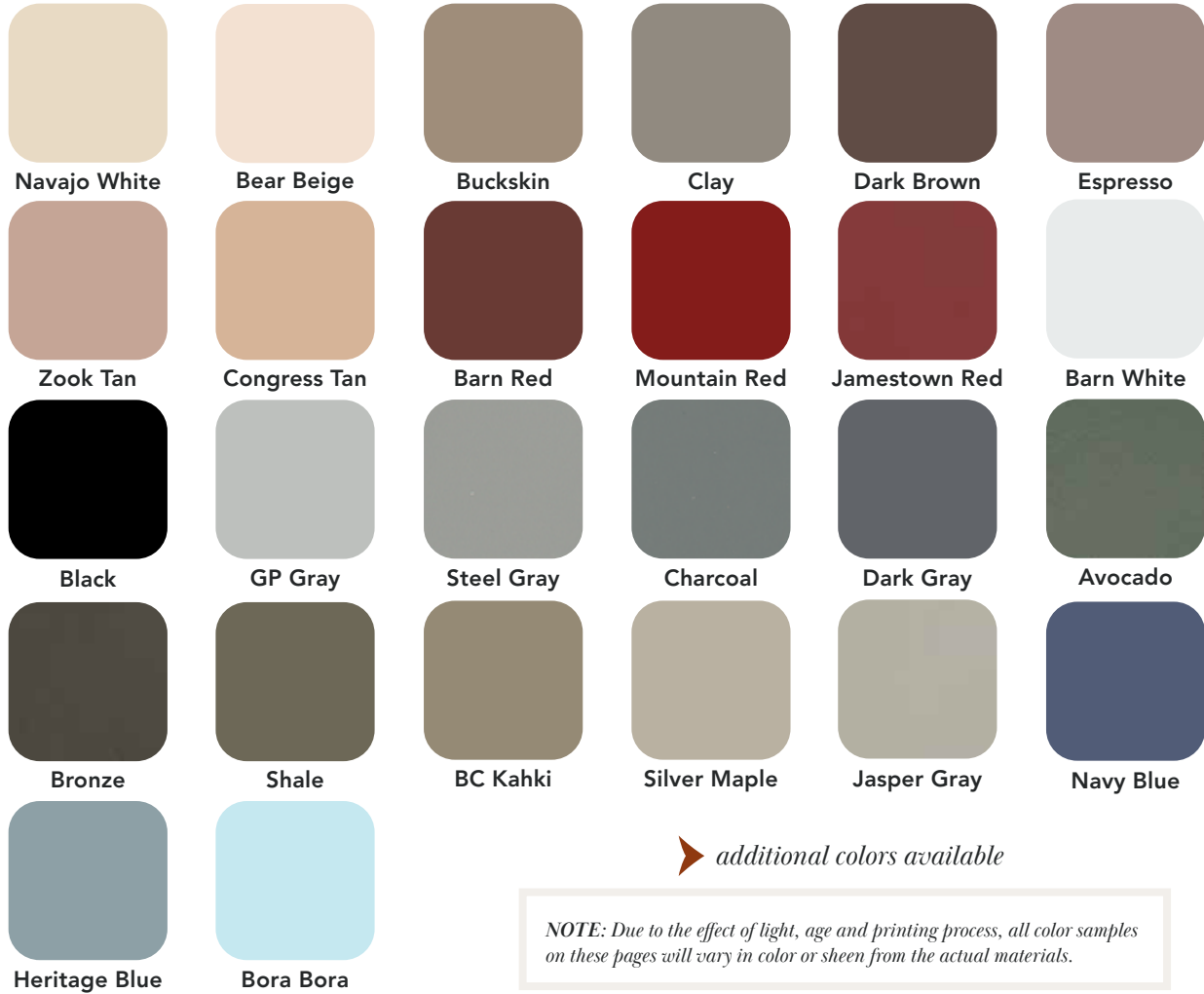

STAIN COLORS

PINE SIDING stain colors



ENGINEERED SIDING stain colors





Weaver Barns *ltd.*

"everyone needs a little structure in their life"

Geitgey's Amish Country Furnishings
7600 Fishel Dr N
Dublin, OH 43016
614-791-8525
amishcountryfurnishings.com

7 YEAR LIMITED WARRANTY

IF ANYTHING GOES WRONG OR IF WE DID SOMETHING WRONG WE WILL TAKE CARE OF IT

EXCLUSIONS: ACTS OF GOD, IMPROPER MAINTENANCE, USER DAMAGE, PAINT & STAIN, SEASONAL SETTling, SHINGLE BLOW-OFFS DUE TO WIND

*ON SIGNATURE MODELS

2024



Like Us
on
Facebook



Follow Us
on
Pinterest



Find Us
on
Houzz



Follow Us
on
Instagram

www.weaverbarns.com